

Integrated Vegetation Management Manual For Maryland Highways



October 2003

**With Cumulative Updates
Republished December, 2023**

Integrated Vegetation Management Manual for Maryland Highways

Neil J. Pedersen
State Highway Administrator

Douglas R. Rose
Deputy Administrator/Chief Engineer for Operations

Douglas H. Simmons
Deputy Administrator/ Chief Engineer for
Planning and Engineering

Russell A. Yurek
Director, Office of Maintenance

Charles B. Adams
Director, Office of Environmental Design

**With Cumulative Updates
Republished December, 2023**

Andrew Shoffner
Deputy Director, Office of Environmental Design

Table of Contents

Part 1 - General

APPROVALS.....	i
INTRODUCTION.....	1.1
STATEWIDE VEGETATION MANAGEMENT TEAM MISSION AND MEMBERS.....	1.2

Part 2 - Herbicide Application Standards

INTRODUCTION.....	2.1
POLICY, PERSONNEL, AND TRAINING.....	2.2
HERBICIDE SAFETY.....	2.4
MAJOR CLASSIFICATION OF HERBICIDES.....	2.8
CHEMICAL MOWING.....	2.14
PLANT GROWTH REGULATORS ON ROADSIDE TURF.....	2.15
Table 1 – PGRs and 2,4-D.....	2.16
BROADLEAF WEED CONTROL.....	2.17
Table 2 – Broadleaf Weed Control.....	2.19
ANNUAL GRASS CONTROL.....	2.20
Table 3 – Annual Grass Control.....	2.21
VEGETATION CONTROL AROUND TRAFFIC BARRIERS, SUPPORTS, AND DELINEATORS.....	2.22

Table of Contents

Table 4 – Control of Vegetation around Traffic Barriers, Supports, and Delineators in Areas not Previously Treated with Soil Residuals.....	2.24
Table 5 –Control of Vegetation Around Traffic Barriers, Supports, and Delineators in Areas Previously Treated with Soil Residuals.....	2.25
NON-SELECTIVE GRASS AND BROADLEAF WEED CONTROL.....	2.27
Table 6 – Weed Control in Pavement Cracks, Concrete Barrier Walls, Highway Shoulders and Storage Areas.....	2.28
BRUSH CONTROL.....	2.29
Table 7 –Brush Control by Stem Foliage, Stump, and Basal Treatments.....	2.33
TREE OF HEAVEN CONTROL	2.33.1
Table 7a – Tree of Heaven Control	2.33.4
POISON IVY CONTROL.....	2.34
Table 8 – Poison Ivy Control.....	2.35
THISTLE CONTROL.....	2.36
Table 9 – Thistle Control.....	2.38
WEED CONTROL IN SHRUB BEDS.....	2.39
Table 10 –Weed Control in Shrub Beds.....	2.41
VEGETATION CONTROL PRIOR TO PAVING.....	2.42

Table of Contents

Table 11 – Vegetation Control Prior to Paving.....	2.43
WIRESTEM MUHLY CONTROL.....	2.44
Table 12 – Wirestem Muhly Control.....	2.45
JOHNSONGRASS CONTROL.....	2.46
Table 13 – Johnsongrass Control.....	2.47
PHRAGMITES CONTROL.....	2.48
Table 14 – Phragmites Control.....	2.49
SPRAYING EQUIPMENT OPERATION AND MAINTENANCE.....	2.50
EQUIPMENT FOR BROADLEAF WEED CONTROL AND APPLICATION OF PLANT GROWTH REGULATORS.....	2.53
Power Spraying 400 Gallon Unit.....	2.53
Drawing 1 – Off-Center Nozzle Spray Patterns.....	2.54
Drawing 2 – Roadside Nozzle Arrangement.....	2.55
Drawing 3 – Components of a Roadside Sprayer.....	2.55
Table 15 – Gallons Per Minute of Operation for Broadleaf Weed Control and PGR Application.....	2.56
Table 16 – Number of Acres Per Mile for Various Spray Swath Widths.....	2.57
Table 17 – Gallons Per Minute for ¾” OC Nozzle Tips.....	2.58

Table of Contents

Table 18 – Feet Travels in 30 Seconds converted to MPH....	2.59
Table 19 – Time Required to Travel One Mile at Various Speeds.....	2.60
EQUIPMENT FOR CONTROL OF VEGETATION AROUND TRAFFIC BARRIERS, SUPPORTS, AND DELINEATORS.....	2.61
Table 20 – Miles Per Hour for Control of Vegetation Around Traffic Barriers.....	2.62
Drawing 4 – Dual ¼” 6510 or 6515 Nozzles held Traffic Barriers.....	2.63
Table 21 – Miles Per Hour for Control of Vegetation Around Traffic Barriers.....	2.64
EQUIPMENT FOR BRUSH CONTROL.....	2.65
EQUIPMENT FOR BRUSH, POISON IVY, PHRAGMITES, AND JOHNSONGRASS CONTROL.....	2.65
EQUIPMENT FOR WIRESTEM MUHLY CONTROL.....	2.65
HERBICIDE DISPOSAL.....	2.66
RECORDS.....	2.67
TEAM ACTIVITY CARD.....	2.68
DETERMINATION OF HERBICIDE USAGE AND ACCOMPLISHMENTS.....	2.69
Tables 22, 23, and 24 – Herbicide Usage	2.69
APPENDIX I – COMPUTATIONS.....	2.72

Table of Contents

APPENDIX II – CALIBRATION SHEET FOR ROADSIDE SPRAYERS.....	2.73
APPENDIX III – U.S. AND METRIC WEIGHTS AND MEASURES.....	2.74
APPENDIX IV – CONVERSION TABLE.....	2.75
APPENDIX V – MARYLAND POISON CONTROL CENTERS.....	2.76
APPENDIX VI – SUSCEPTIBILITY OF WEEDS	2.77

Part 3 - Mowing Standards

INTRODUCTION.....	3.1
GOALS.....	3.1
PURPOSE FOR MOWING.....	3.1
MOWING PRACTICES.....	3.3
MOWING PRIORITIES AND HEIGHTS.....	3.4
MOWING GENERAL AREAS.....	3.5
MOWING SPECIFIC AREAS.....	3.7
MOWING SUMMARY (CHART).....	3.8

Part 4 - Woody Vegetation Management Standards

INTRODUCTION.....	4.1
GOALS.....	4.1
PURPOSE.....	4.2

Table of Contents

FLAT AREAS.....	4.4
SLOPES.....	4.8
CUT SLOPES.....	4.9
BRIDGE ABUTMENTS.....	4.11
FILL SLOPES.....	4.12
TREE LAWS	4.13
ROADSIDE TREE LAW APPLICATION FOR PERMIT PUBLIC AGENCY (RTPA).....	4.14
ROADSIDE TREE LAW APPLICATION FOR PERMIT PUBLIC AGENCY (RTPA) SAMPLE.....	4.16
ROADSIDE TREE LAW APPLICATION FOR PERMIT INDIVIDUAL (RTI).....	4.18
ROADSIDE TREE LAW APPLICATION FOR PERMIT INDIVIDUAL (RTI) SAMPLE.....	4.19

Part 5 - Wildflowers

WILDFLOWER PROGRAM.....	5.1
EROSION AND SEDIMENT CONTROL	5.6
WILDFLOWER IDENTIFICATION GUIDE.....	5.15
WILDFLOWER PLANTING AND BLOOM SCHEDULE..	5.19

Parts 6 - 8 - Reserved

Part 9 - Glossary

GLOSSARY.....	9.1
---------------	-----

Table of Contents

Part 10 – Index (Under Construction)

INDEX	10.1
-------------	------

INTRODUCTION

The Integrated Vegetation Management Manual for Maryland Highways depicts definitive maintenance activities for State Highway Administration (SHA) roadsides and medians. These activities involve application of herbicides, mowing and the management of woody vegetation. In order to maximize the efficiency of funds, an integration of these activities must be utilized.

Each section of the manual provides a description of when and how the work should be performed using Best Management Practices, allowing the Administration to maximize its resources of personnel, equipment and materials.

Conducting these activities as outlined provides the greatest safety for the motoring public and maintenance personnel.

Activities outlined in this document encourage environmental stewardship, sustainability of the roadside, and the enhancement of aesthetics. The activities are updated annually by the Statewide Vegetation Management Team (SVMT).

OBJECTIVES

The Integrated Vegetation Management Manual for Maryland Highways accomplishes the following objectives for all personnel by providing for a:

- Reference of each maintenance activity.
- Description and purpose of each maintenance activity.
- Guide of when each maintenance activity should be performed.
- Guide to help ensure the statewide uniformity in Roadside Vegetation Management.
- Basis for support of State Highway Administration's (SHA) Business Plan.

Introduction

MISSION

The mission of the Statewide Vegetation Management Team (SVMT) is to review roadside vegetation issues and develop management strategies to support SHA's mission involving highway safety and environmental stewardship.

MEMBERS

The team is comprised of members from each District, the Office of Maintenance, and the Office of Environmental Design. Members are as follows:

James Jackson	Snow Hill Shop	410-632-0511
Stanley Lake	Denton Shop	410-479-0770
Gregory Holsey	Centerville Shop	410-758-0700
William Purdum	Gaithersburg Shop	301-948-2477
Edward Railey	Churchville Shop	410-838-7788
Jim Morgan	Annapolis Shop	410-841-1009
Mike Layman	LaVale Shop	301-729-8483
Randy Houck	Frederick Shop	301-624-8250
Gene Keller	Frederick Shop	301-624-8250
Richard Gilmore	Highway Maintenance Division	410-982-5542
Carl Senos	Landscape Operations Division	410-221-1635
Bill Klingelhofer	Landscape Operations Division	410-780-6224
Larry Gunter	Landscape Operations Division	410-780-6226
Jodie Shivery	Landscape Operations Division	410-810-3285
Laura Stedman	Landscape Operations Division	410-545-8588
Bruce Knott	Landscape Operations Division	410-780-6233
Don Cober (Team Leader)	Landscape Operations Division	410-545-8596
Kenneth Oldham (Team Sponsor)	Office of Environmental Design Landscape Operations Division	410-545-8590

Herbicide Application Standards

INTRODUCTION

The Herbicide Application Standards was developed to familiarize personnel with the principles and practices associated with the application of herbicides to roadside vegetation.

The manual cannot cover all the changes and variations that will arise in an extensive herbicide program; therefore, the Landscape Operations Division (LOD) should be consulted as to details of application and as to any unusual situations. Furthermore, this manual is not intended to take the place of an experienced certified pesticide supervisor.

Herbicides permit the control of selected vegetative growth on the highway roadsides by chemicals rather than by hand or machine cutting. Properly used, herbicides can eliminate undesirable weed and brush growth thereby reducing or eliminating mowing or cutting. Adequate sight distance can be maintained without periodic removal of woody growth. The area under traffic barriers can be maintained at a desired height or free of vegetation, reducing or eliminating the need of hand mowing. Noxious and nuisance plants can be controlled to the benefit of the traveling public, highway personnel, and the adjacent landowners.

While the benefits of proper application are obvious, improper use could result in serious damage claims, strained relations with the public and regulatory agencies fines and the revocation of permits.

The basic objectives of the herbicide program are to:

- Achieve economy in roadside maintenance by substituting herbicides for mechanical mowing. For optimum results, proper mowing practices (frequency and height) must be used in conjunction with the herbicide program.
- Maintain highway safety by using herbicides to economically control brush and weed growth that interferes with adequate sight distance.
- Improve turf quality, cover, and appearance by eliminating unsightly weed growth on highway roadsides.
- Control noxious weeds such as Johnsongrass and Thistles, which must be controlled to avoid spreading to uninfested areas.
- Control unlawful nuisance and invasive plants such as Tree of Heaven and phragmites.
- Control nuisance weeds such as dandelion, chicory, ragweed, wild garlic, and poison ivy.

Policy, Personnel and Training

POLICY

Laws

All application of herbicides on Maryland State Highway Administration (SHA) right-of-way must be done in accordance with the Maryland Regulations pertaining to the Pesticide Applicators Law. These laws pertain to all phases of herbicide storage, mixing, application, and record keeping.

Personnel

All personnel involved in the application of herbicides on SHA right-of-way are required to be **certified** and/or **registered** by the Maryland Department of Agriculture (MDA). Resident Maintenance Engineers, Assistant Resident Maintenance Engineers, Facilities Maintenance Technician Supervisors, Facilities Maintenance Technician, drivers, and applicators must be registered.

All in-house and contract herbicide applications are required to be performed under a SHA **supervisor** who is **certified** by MDA. For the most effective program, each shop performing the above applications must have at least the Assistant Resident Maintenance Engineer, or a Facilities Maintenance Supervisor I and a Facilities Maintenance Technician IV certified. This provides a consistent and continuous flow of information and instructions to all application personnel.

These personnel shall be provided registration and certification training by the Landscape Operations Division (LOD) of the Office of Environmental Design.

Training

Prior to MDA registration each person must complete a LOD Pesticide training program containing the following subjects.

- Pesticide laws and regulations
- Label comprehension
- Protecting the pesticide applicator
- Proper pesticide handling and storage
- Pesticides and the environment
- Pesticide application techniques
- Integrated pest management principles
- Record keeping
- Public relations

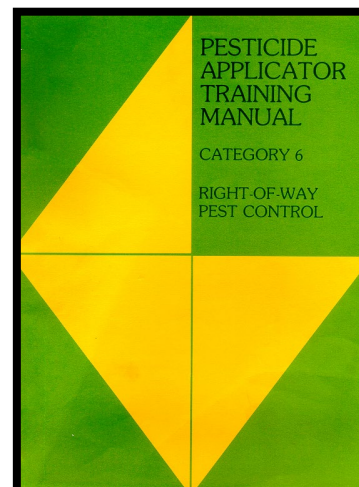

Policy, Personnel and Training

Safety

All personnel must observe the precautions outlined in this manual as well as those given on the manufacturer's label.

Herbicides other than those recommended in this manual may not be used even on a trial basis without the prior approval of the Landscape Operations Division (LOD). Only the rates and mixtures of the herbicides recommended in this manual may be used. These methods have been tested and proven effective and safe. By limiting our herbicide use to the products and practices outlined in this manual our liability as an administration is also reduced.

Property Damage

The precautions necessary to maintain good public relations and to avoid property damage must be carefully observed to avoid "drifting" of herbicides, caused by too much pressure, over application and spraying under windy conditions.

Aesthetics

SHA policy is to avoid spraying woody growth over three (3) feet in height. The objective of this policy is to continue to have attractive roadsides free of foliage "brown-out", or standing dead brush due to herbicide application. The appearance of our roadsides is a reflection of overall maintenance of the highway to the motoring public.

HERBICIDE SAFETY

Even the least toxic herbicide can be hazardous when mishandled. The herbicides, identified in this manual, used in vegetation control are of moderate or low toxicity and are further diluted when used as sprays. All herbicides regardless of toxicity shall be used in accordance to the following guidelines as well as the manufacturer's label.

Application Rates

Apply herbicides at rates recommended in this manual. Over-application is not economical and may be injurious to nearby vegetation. Under-application will not give the desired results and may result in a complete waste of time and materials.

Label Instructions

Be familiar with the herbicides you are using. **Read** and **follow** the manufacturer's instructions on the label and in this manual concerning their use. A label and a material safety data sheet (MSDS) must be present when applying.

Drift

Herbicide solutions are applied above the ground and special precautions must be observed to see that the herbicide is applied only to the desired target area. Movement through the air can result in **spray drift** or **volatilization**.

Spray drift is the movement of airborne spray particles. The amount of spray drift depends upon the size of the droplets, wind velocity and the height of the spray.

The size of the droplet will depend primarily upon the pressure being applied to the outlet nozzle, **the lower the pressure, the larger the droplets**. Large droplets are less likely to drift. Pressure at the nozzle should **not exceed 40 PSI**.

The amount of wind velocity and spray release height is directly proportional to spray drift. The greater the wind velocity and the spray release height, the greater is the chance of spray drift. Avoid spraying when wind is strong enough to alter spray patterns or carry the spray off target. A wind meter shall be used to determine wind velocity in miles per hour (MPH) at the application site. Drift control agents are available to reduce drift.

Volatilization

Volatilization is the tendency of the herbicide to vaporize or give off fumes. The amount of fumes or vapors given off is related to the vapor pressure of the herbicide. Use only the amine formulation of 2,4-D, and not the ester formulation.

Herbicide Safety

Air temperature

Air temperature is an important element in the safe application of herbicides. All applications shall cease when the air temperature exceeds 90°F.

Drought

Drought conditions can reduce the effectiveness of herbicides. Plants fail to absorb and process herbicides during drought. Application should be avoided if these conditions exist.

Spray Equipment

Check daily all spray equipment and nozzle(s) discharge volume in gallons per minute output to prevent failures and ensure correct rate of application. Stop all leaks that occur immediately and maintain a clear site gauge.

Personal Protective Clothing

SHA wants to provide each employee working with herbicides the safest possible working and health conditions. It shall be mandatory to wear the following Personal Protective Clothing and Equipment:

- Respirators** – NIOSH approved respirators **must** be worn by all personnel during mixing, dilution and other handling of concentrated materials. The respirators shall be approved for pesticide usage and be equipped with disposable cartridges.
- Eye Protection** – A face shield, or flexible fitting hooded ventilation glasses **must** be worn during handling of concentrated materials. A portable eye wash unit must be available on each herbicide application truck.
- Clothing** – Impervious garments such as disposable or reusable long sleeved shirts, long trousers, shoes and socks **must** be worn during the mixing, handling of and application.
- Gloves** – Long sleeved (1/2 forearm length) unlined rubber or chemical resistant gloves **must** be worn during mixing of herbicides, and in any hand operation such as “hand sprayers”, or spot spraying with a hand held nozzle.
- Footwear** – Rubber boots **must** be worn when application methods require walking through treated areas.
- Full-length aprons** – An impervious apron **must** be worn during the mixing of herbicides.
- Disposable coveralls** – They **must** be made available to application personnel.

Herbicide Safety

- Water** – At least one (1) gallon of fresh water **must** be carried in the spray truck for sanitation purposes.

First Aid

Read and observe the precautions provided on the manufacturer's label. Avoid getting herbicides in the eyes, on the skin or on clothing. In case of eye contact, flush eyes with plenty of fresh water for at least fifteen (15) minutes and get immediate medical attention. In case of skin contact, wash skin with soap and plenty of water. If herbicide poisoning is suspected, refer to the Poison Control Centers listed in Appendix V.

Protecting the Public and Wildlife

- Do not** spray when the public, pets or wildlife are in the application area.
- Do not** spray in front of schools, on school property or at school bus stops.

Protecting Water Sources

- Use every precaution to **avoid contamination** of ponds, streams, lakes, ground water or other water sources when filling or flushing tanks and applying herbicides.
- Fill** spray tanks from a water supply tank, spigot or fire hydrant. All spray and water supply tanks are required to have an anti-siphon device in the form of an air-gap.
- Do not** apply herbicides within one-half mile of a water supply reservoir.
- Do not** apply 2,4-D within fifty (50) feet of the edge of a stream, lake or pond.
- Do not** apply herbicides around traffic barriers and around supports if within twenty-five (25) feet of the edge of a stream, lake or pond.
- Do not** apply herbicides near open wells and spring heads, to avoid contaminating ground water.

Storage

- Building** – Herbicides should be stored in a cool, dry, ventilated, well light, heated room on the ground floor or a separate building. Freezing can cause permanent physical changes, leading to loss of effectiveness. Overheated herbicides can lose their strength and breakdown. There should be no chance that runoff or drainage from the site could contaminate surface or

Herbicide Safety

groundwater. A spill kit and fire extinguisher should be available. The storage area should be fenced and locked. A sign should be posted outside on the door reading: **DANGER PESTICIDES STORED**.

- Never store food, drink, seed, fertilizer or living plants in the same room with herbicides.**
- Arrangement – Herbicide containers should be stored with the label in plain sight and in readable condition. They should be stored off the floor especially if they can be affected by dampness. Periodically check the containers for corrosion, leaks, loose caps or bungs. If the original container is damaged put the herbicide in a new sturdy container that can be sealed. Be sure to label the new container with all the required information. Never store herbicides in anything used for food or drink.

Public Relations

While spraying, always work in a manner, which will maintain the best possible public relations. Besides following approved application procedures, one must be able to discuss numerous aspects of the spraying program with the public, listen to the public's concern and provide information consistent with excellent customer service. When unable to answer questions, refer the public to a certified pesticide supervisor.

When spraying any area at Rest Areas, Information Centers, District Offices and County Shops the applicator is **required by law** to post spray-warning signs. Signs should be in a location highly visible to the public. **Signs are to be removed 48 hours after the area is sprayed unless otherwise stated on the label.** The back of the sign is to be filled out with the requested information. Signs can be obtained through the Landscape Operations Division.

The following is an example of an appropriate sign:

FRONT

CAUTION
PESTICIDE APPLICATION

KEEP  OFF

CUSTOMER: PLEASE REMOVE AFTER 48 HOURS.

MARYLAND 1988

BACK

Date Applied _____

Company Name _____

Phone # _____

MAJOR CLASSIFICATION OF HERBICIDES

The herbicides discussed below have been registered with the United States Department of Agriculture (USDA), the Environmental Protection Agency (EPA) and the Maryland Department of Agriculture (MDA) for use as recommended in this manual. When applied as directed, they should have no adverse effect on humans, domestic animals or wildlife.

Most of the herbicides now in general use are classified as being selective rather than non-selective. A **selective herbicide** means that it is more toxic to one plant or group of plants than to another. A **non-selective herbicide** is injurious to most plants with only a few plants being tolerant.

Some herbicides are **contact** inhibitors while others are **translocated** (systemic). A contact herbicide inhibits only the growth it contacts often leaving the roots viable for regrowth. A translocated herbicide moves throughout the plant including the roots and therefore can control the entire plant. Contact herbicides are faster acting and most translocated herbicides are somewhat selective.

Most herbicides are applied to the foliage of the vegetation while others are applied to the soil. When herbicides are applied to the foliage, the most effective results are obtained when the plants are growing vigorously and have adequate leaf area for the spray material to contact.

When herbicides are applied to the soil surface time must be allowed for the herbicide to move into the roots and throughout the plant. Conditions such as moisture, vegetative cover, slope, texture and organic matter play an important role in the control obtained from any specific herbicide. Often, in order to obtain better and faster result, a combination of herbicides is used.

Herbicides now in general use can be broken down into two basic types:

- Herbicides applied to foliage and stems.
- Herbicides applied directly to the soil.

Herbicides applied to foliage and stems

These herbicides are applied to existing vegetation. The herbicide is absorbed into the plant cells and some may be translocated throughout the entire plant system. Some are effective in controlling grasses, others will control broadleaf weeds and still others are effective brush killers. These herbicides are categorized as selective herbicides, non-selective herbicides and plant growth regulators.

Selective Herbicides

2,4-D Water Soluble Amine (WSA)

2,4-D Water Soluble Amine contains 3.8 or 5.6 pounds active ingredient (acid equivalent) per gallon. 2,4-D WSA is a selective hormone herbicide in liquid form for the control of many broadleaf weeds and certain woody plants. 2,4-D WSA is non-volatile and safe to apply when temperatures exceed 70°F but not above 90°F.

Garlon 3A (triclopyr*)

Garlon 3A contains three (3) pounds active ingredient per gallon. Garlon 3A is an auxin type herbicide in a liquid amine formulation that selectively controls many broadleaf weeds and woody plants. Garlon 3A can be applied when applied when air temperatures exceed 70°F but not above 90°F.

Pathfinder II (triclopyr*)

Pathfinder II is a two (2) way mixture containing a low-volatile ester of Garlon 4E triclopyr, a vegetable oil, and a dye. Pathfinder II is a 13% pre-mixed Cut Stump/Basal Stem RTU (ready to use) herbicide used for brush control. This chemical is to be used only when the temperature is below 85°F.

MSMA 6 WS (monosodium methanersonate*)

MSMA 6 WS (water soluble) contains six (6) pounds active ingredient per gallon. MSMA 6 WS is a liquid combination of herbicide and surfactant useful for selective post-emergent weed control, particularly for grassy weeds. The phytotoxic properties are quickly inactivated on soil contact. Best results are obtained on young, actively growing weeds at air temperature above 80°F.

Vanquish (diglycolamine*)

Vanquish contains four (4) pounds active ingredient per gallon. Vanquish is selective, post emergence, liquid amine herbicide used to control phenoxy tolerant broadleaf weeds, kudzu, and brush species. Vanquish can be used as a foliar or stump treatment, usually in combination with other herbicides.

Velpar (hexazinone*)

Velpar contains two (2) pounds active ingredient per gallon. Velpar is a selective, post emergence herbicide to control thistle in crownvetch.

*** Chemical Name**

NOTE: All recommended rates of herbicides are given in pounds per acre. “Pounds of dry flowable” refer to net container weight and “pounds of liquids” refer to pounds of active ingredient. The proper herbicide rate must be determined from this manual.

Transline (clopyralid*)

Transline contains three (3) pounds active ingredient per gallon. Transline is a selective liquid herbicide used to control phenoxy tolerant broadleaf weeds such as thistle and clover. Transline should not be applied near legume trees such as locust, red bud, catawaba and others to prevent damage. Avoid contamination to surface and groundwater.

Krenite S (fosamine*)

Krenite S contains four (4) pounds active ingredient per gallon. Krenite S is a liquid combination of herbicide and surfactant for mid-to-late season brush control. Krenite S produces little “brown out”.

Non-Selective Herbicides

Non-Selective Herbicides control nearly all types of vegetation regardless of whether they are grasses or broadleaf plants.

Glyphosate*

Glyphosate contains four (4) to five (5) pounds of active ingredient per gallon. Glyphosate is formulated as a liquid combination of herbicide and surfactant and is very effective for the control of grasses and some broadleaf plants.

Aquatic (glyphosate*)

Aquatic glyphosate contains 5.4 pounds of active ingredient per gallon of acid glyphosate. It is labeled for use on emerged vegetation in and around aquatic sites and contains no surfactant. An aquatic surfactant must be added when applying this product.

Plant Growth Regulators (PGRs)

PGRs are used on turf to reduce the number of mowings normally required. PGRs can delay mowing up to eight (8) weeks. They are not detrimental to the turf when used at the recommended rates. Treatment should begin in the spring when dandelions are blooming and before the turf reaches a height of six (6) inches, therefore, confining application to a two (2) or (3) week period from April to early May. Treat turf at green-up but prior to formation of seed heads. Apply only one application per year. Desirable turf should be well established before application. The following products are used together for the suppression of plant growth.

*** Chemical Name**

NOTE: All recommended rates of herbicides are given in pounds per acre. “Pounds of dry flowable” refer to net container weight and “pounds of liquids” refer to pounds of active ingredient. The proper herbicide rate must be determined from this manual.

Embark 2-S (mefluidide*)

Embark contains two (2) pounds active ingredient per gallon. This liquid PGR is used in combination with the PGR Telar. When applied to turf, Embark reduces mowing by regulating growth and suppressing seed head formation.

Telar (chlorsulfuron*)

Telar is a 75% dry flowable dispersible granule. This herbicide used as a PGR will suppress grass growth and inhibit seed head formation.

Herbicides Applied Directly to the Soil (Soil Residuals)

Herbicides in this group are generally non-selective and are applied to the soil where they are taken in by the roots and are translocated throughout the entire plant system. They are effective in controlling most vegetative growth and have the advantage of a residual (carry over) effect, which retards regrowth in the treated area for three (3) to six (6) months. Extreme caution must be used when applying soil residuals since excessive rates don't dissipate (become inactive) quickly and; therefore, they could move into non-target areas such as tree roots. The length of time and effectiveness depends on the amount of rainfall, nature of the soil, the herbicide selected and the rate applied.

Hyvar X-L (bromacil*)

Hyvar X-L contains two (2) pounds of active ingredient per gallon and is easily suspended in water with mild agitation. It effectively controls most grasses and weeds at low rates. It is used to extend the life of asphalt and stone pavements by preventing weeds from emerging through them. The material is applied just before the placement of asphalt or asphalt solutions. Continuous agitation is required during application.

Pramitrol 25E (prometone*)

Pramitrol contains two (2) pounds of active ingredient per gallon and effectively controls most grasses and weeds. It is used to extend the life of asphalt and stone pavements by preventing weeds from emerging through them. The material is applied just before the placement of asphalt or asphalt solutions. Continuous agitation is required during application.

Surflan AS (oryzalin*)

Surflan AS contains four (4) pounds of active ingredient per gallon and is a non-selective preemergence surface-applied herbicide for control of annual grasses and many broadleaf weeds. Vigorous and continuous agitation is required for all tank-mixes. If Surflan AS is not activated by rainfall within twenty-one (21) days of application, erratic weed control may result.

*** Chemical Name**

NOTE: All recommended rates of herbicides are given in pounds per acre. "Pounds of dry flowable" refer to net container weight and "pounds of liquids" refer to pounds of active ingredient. The proper herbicide rate must be determined from this manual.

Ronstar G (oxadiazon*)

Ronstar G contains two (2) pounds of active ingredient per one hundred (100) pounds of product. Ronstar G is a granular, selective, preemergent herbicide used as a weed control in shrub beds.

Snapshot 2.5TG (trifluralin* and isoxaben*)

Snapshot 2.5 TG contains one and one quarter (2.50) pounds of active ingredient per one hundred (100) pound bag. Snapshot 2.5TG is a granular, selective, preemergent herbicide used as a weed control in shrub beds. If Snapshot 2.5 TG is not activated by rainfall within three (3) days of application, erratic weed control may result.

Additives and Adjuvants

Additives and adjuvants are substances added to the spray mixture to aid or improve the performance and safety of herbicide applications.

Additives such as drift controls or colorants are used to improve the safety of herbicides. The viscosity of the herbicide mix may need to be changed so that fewer fine droplets will be formed and drift will be reduced. Colorants are added to indicate spray patterns and mark plants that are treated.

Adjuvants are highly active materials. In most cases, a very small quantity will have a great effect. Be careful to use only the amount recommended. Too much adjuvant may be just as ineffective as too little. Too much of some adjuvants may cause run off of the herbicide because a thin film deposit may develop on the foliage or may cause the herbicide spray to lose some of its selectivity and can injure plants that may normally be tolerant. Depending upon their intended use, adjuvants are called emulsifiers, wetters, stickers, extenders, spreaders, deposit builders, film formers, buffering agents, penetrants, foaming agents, and anti-foaming agents. Proper selection of an additive or adjuvant for the job is very important.

Additives may be added to the spray mixture to:

- Reduce spray injury to desirable vegetation.
- Reduce drift hazard.
- Act as a spray pattern indicator.

*** Chemical Name**

NOTE: All recommended rates of herbicides are given in pounds per acre. “Pounds of dry flowable” refer to net container weight and “pounds of liquids” refer to pounds of active ingredient. The proper herbicide rate must be determined from this manual.

Adjuvants may be added to the spray mixture to:

- Improve the wetting of the foliage or the pest.
- Change the evaporation rate of the spray.
- Improve the ability of the spray deposit to resist weathering.
- Improve the penetration, absorption and translocation of the herbicide.
- Improve the uniformity and amount of the deposit.
- Improve the ease of mixing or compatibility of the spray mixture.
- Improve physical properties of the mixture (i.e., anti-foaming agents).

Chemical Mowing

COORDINATION OF CHEMICAL AND CONVENTIONAL MOWING

Chemical mowing is the application of herbicides to eliminate tall growing broadleaf weeds such as chicory or thistle or to slow down turf growth in hard to mow areas. When chemical mowing is used in conjunction with conventional mowing, the most important principle involves correct timing of the two programs. Improper timing can destroy all benefits obtained from chemical mowing by interfering with the ability of the herbicide(s) to perform their function. When these two programs are coordinated properly, highway vegetation can be maintained at the lowest unit costs, with the least amount of personnel and equipment and at the same time achieve desirable turf appearance.

CONVENTIONAL MOWING FOLLOWED BY CHEMICAL MOWING

When conventional mowing **precedes** chemical mowing, the chemical mowing should be delayed five (5) to seven (7) days before application of herbicides. This allows time for the vegetation to recover so adequate leaf foliage exists for the foliar herbicide application to be most effective. This rule applies to broadleaf weed controls as well as plant growth regulators.

CHEMICAL MOWING FOLLOWED BY CONVENTIONAL MOWING

When chemical mowing **precedes** conventional mowing, which is often the case in broadleaf weed control adequate time must be allowed for the herbicide(s) to perform its function. Normally five (5) to seven (7) days are allowed before conventional mowing should begin. If dry or cold weather conditions prevail during this time, conventional mowing should be delayed two (2) or three (3) additional days for a total of ten (10) days delay. These procedures **must** be followed if maximum results are to be obtained from a chemical-mowing program.

When plant growth regulators are applied at the proper time and rate conventional mowing should not be needed for up to eight weeks.

The following sections discuss in detail the many ways herbicides can be used to manage roadside vegetation.

Plant Growth Regulators

PLANT GROWTH REGULATORS ON ROADSIDE TURF

(See Table 1 for Detailed Recommendations)

Objectives

Plant Growth Regulators (PGRs) can be applied to roadside turf, as a way of chemical mowing, to accomplish the following:

- Reduce the number of required mowings in areas where a neat, well-maintained appearance is desirable and where mowing is difficult or hazardous. Examples are narrow medians on heavily traveled routes, medians with deep ditch sections where mowing is extremely difficult, and median and roadside urban areas where numerous mowing obstructions exist.
- Eliminate all mowing on steep cuts and fills in urban areas where tall, unkept growth is objectionable.
- Reduce the number of mowings required where traffic barriers exist.

Materials

The PGRs recommended to date are a combination of Embark and Telar DF. They are effective on most cool season grasses found on our roadsides. 2,4-D WSA must be added to provide broadleaf weed control, which is essential if satisfactory results are to be obtained. Thorough mixing of PGRs and 2,4-D WSA with the water carrier is essential, and continuous agitation is required.

Method of Application

Low pressure, high volume applications using broadcast Off-Center Nozzles have been proven effective in obtaining the uniform coverage required. (Refer to Spraying Equipment Operation and Maintenance Section for Details.)

A 400 gallons or larger sprayer either truck or trailer mounted is recommended for the duration of the spraying operation so the necessary piping and placement of nozzles may be permanently installed. Controls for the operation are to be mounted inside the truck cab or on the truck tailgate.

Recommended Program

Timing and rate of application are very important. Treatment should be made in the spring when dandelions are blooming. Apply when grass reaches four (4) inches but before six (6) inches of height. This confines the spraying to a two (2) to three (3) week period (generally starting early to mid-April depending on season and location).

Rates of application must be closely regulated. Too little PGR and the turf will rapidly recover. Over-application will result in browning of the grass and may seriously injure the turf cover, leaving it open to invasion of undesirable annual weeds and grasses.

Plant Growth Regulators

Precaution

Since 2,4-D WSA should always be included in the spray mixture to control broadleaf weeds, the precautions outlined under “Broadleaf Weed Control”(page 20) must be observed.

Table 1

PGRs and 2,4-D

Materials	Rate per Acre				Pressure*	Time of Application
	Dry Measure	Pounds	Liquid Measure	Water (gal)		
Telar DF**	0.25 oz	--	--	50	15-40	In spring after growth starts and before it reaches a height of 6” (early to mid-April in most areas of the state).
+						
Embark (2 lbs/gal)	--	0.19	¾ pint			
+						
2,4-D WSA (5.6 lbs/gal)	--	1.4	1 quart			
+						
Wetting Agent	--	--	1 pint			
+						
Drift Control	--	--	1 to 3 oz			

* These pressures are the general operating pressures. The actual operating pressure should be adjusted to obtain the desired gallons per minute at the nozzle and will be determined at calibration.

** Use only the measuring device that is supplied with the product.

Broadleaf Weed Control

BROADLEAF WEED CONTROL (See Table 2 for Detailed Recommendations)

Objectives

The primary objective of broadleaf weed control is to reduce the number of machine and/or hand mowings required on highway roadsides. Additional benefits are control of noxious weeds, improved sight distance, improved turf quality and appearance and improved drainage.

Material

The material recommended is 2,4-D WSA applied in water to foliage of weeds during the active growing season. Applied at the rate recommended, 2,4-D is effective on most broadleaved weeds. Garlon 3A may be added to control difficult weeds such as milkweed, thistle and poison ivy. Vanquish may be added to control wild garlic.



Method of Application

Sprayers capable of low pressure, high volume using Off-Center or Fan TeeJet Nozzles have proven to give the greatest coverage with the least amount of drift.



Recommended Program

For cool season weeds, such as dandelion and chicory, best results are obtained in the spring months between April 1 and June 1, and in the fall between September 1 and October 31. For warm season weeds, such as ragweed and lambsquarter, treat in the summer between July 1 and August 30 when they are in active growing condition.

April 1 to June 30

Spraying during this period will kill young weeds before they reach objectionable heights and will reduce the number of mowings required during the season. In addition, the earlier part of this period is one of the safest periods in which to apply herbicides on the Eastern Shore and in the tobacco area of Southern Maryland before most susceptible crops have been planted.

Broadleaf Weed Control

July 1 to August 30

A certain amount of spraying to kill broadleaf weeds can be done on areas previously mowed, providing there has been enough rain to promote active growth. Rapid growing summer annuals such as ragweed and lambsquarter can be sprayed and controlled at this time.



September 1 to October 31

Spraying during this period will kill young, over-wintering weeds and result in reducing mowing the following year on areas so treated. In the latter part of this season, it is also safe to spray in areas where the most susceptible crops have been harvested.



Precautions

Every effort must be made to reduce the possibility of damage to the crops or plants outside the area to be sprayed, in order to provide customer service and minimize insurance claims.

Drift and volatility are the principal factors associated with damages to plants outside the sprayed area. Drift is the actual movement of the chemical in droplet or vapor form from the point of application to adjacent areas by wind currents. Volatilization is the process in which the liquid or solid chemical is changed into a vapor.

Spraying during periods of high wind velocity will generally result in damage to any susceptible nearby plants. High pressure, in combination with small size nozzle openings, results in a fog of fine spray particles, thereby contributing to the problem of drift. Always use a drift control agent.

Drift may also occur with vapors. Volatilization occurs when high temperatures cause gases to be released in sufficient quantities to severely damage susceptible crops or plants near the treated area.

The following rules should be observed:

- Stop all spraying when the wind is strong enough to cause drift. Generally speaking, no spraying should be done when the wind exceeds five (5) MPH.
- Use as low a pressure and as large a nozzle tip as possible to give the desired coverage and to reduce the possibility of drifting.
- Do not spray near susceptible crops:** corn, potatoes, tobacco, soybeans, tomatoes, grapes, flowers, gardens, or ornamental shrubs and trees.
- Do not spray when the temperature reaches 90°F due to volatilization.

Broadleaf Weed Control

Table 2

Broadleaf Weed Control

Rate per Acre					
Materials	Pounds	Liquid Measure	Water (gals)*	Pressure**	Where Used
2,4-D WSA (5.6 lbs/gal)	1.9	1/3 gal	50	15-40	Turf areas where broadleaf weeds exist.
2,4-D WSA + Garlon 3A (3 lbs/gal)	1.4 1	1/4 gal 1/3 gal	50	15-40	Turf areas where milkweed, thistle, brush or Poison Ivy exists.
2,4-D WSA + Vanguish (4.0 lbs/gal)	1.4 2	1/4 gal 1/2 gal	50	15-40	Turf areas where broadleaf weeds and wild garlic exist.

NOTE: All applications should be made when temperatures are between 50°-90°.

* The amount of water will vary with the season and weather conditions. A minimum of 35 gallons per acre can be used under ideal conditions. The rate required may increase to 100 gallons per acre during hot, dry weather in mid-summer or when growth is exceptionally tall and heavy.

** These pressures are the general range of operating pressures. The actual operating pressure should be adjusted to obtain the desired gallon per minute output at the nozzle and will be determined at calibration.

Annual Grass Control

ANNUAL GRASS CONTROL (See Table 3 for Detailed Recommendations)

Objectives

The primary objective of annual grass control is to control annual grasses such as barnyard grass and foxtail in mowed turf on our highways. Perennial grass quality and appearance will be improved and the number of mowings can be reduced.



Material

The material recommended is MSMA a postemergent herbicide. It is applied in water to foliage of grass weeds during warm weather. Weeds must be in an active growth stage.

Method of Application

Sprayers capable of low pressure, high volume using off-center or fan TeeJet nozzles are to be used to obtain adequate coverage.



Recommended Program

Make applications during warm weather when temperature is between 80° - 90°F. Weeds should be young and actively growing. Application should be uniform and thorough to adequately wet all undesirable weeds growing in turf. MSMA can be used with 2,4-D for a combination control of broadleaf weeds and annual grasses. Two or more repeat treatments at 14-day intervals may be necessary.

Precautions

- MSMA is somewhat corrosive to certain metals. Do not use galvanized steel or aluminum equipment.
- Do not treat new turf until after three (3) mowings.
- Do not apply if rain is expected within 24 hours.
- If 2,4-D is used, do not mix MSMA and 2,4-D together in a slurry bucket. Add each herbicide separately to the water in the tank.
- See Precautions under “Broadleaf Weed Control”.

Annual Grass Control

Table 3

Annual Grass Control

Materials	Rate per Acre			Pressure**	Where Used
	Pounds	Liquid Measure	Water (gals)*		
MSMA WS (6 lbs/gal) +	2.0	1 quart	50	15-40	Turf areas where annual grasses exists.
2,4-D WSA*** (5.6lbs/gal)	0.7	1 pint			

NOTE: Applications should be made when temperatures are between 80°-90°.

*The amount of water will vary with the season and weather conditions. The rate required may increase to 100 gallons per acre during hot, dry weather in mid-summer or when growth is exceptionally tall and heavy.

** These pressures are the general range of operating pressures. The actual operating pressure should be adjusted to obtain the desired gallon per minute output at the nozzle and will be determined at calibration.

*** If 2,4-D WSA is used, do not mix MSMA and 2,4-D together in a slurry bucket. Add each herbicide separately to the water in the tank.

Vegetation Control Around Traffic Barriers

VEGETATION CONTROL AROUND TRAFFIC BARRIERS, SUPPORTS, AND DELINEATORS (See Table 4 for Detailed Recommendations)

Objective

The objective of this treatment is to control all vegetation in a maximum two and one half (2.5) foot or three (3) foot wide band in the line of traffic barriers and immediately adjacent to the base of supports and delineators in order to eliminate hand mowing. Treatment around supports and delineators shall not exceed 6 to 12 square feet or an area (2.5 feet by 4.5 feet).



Material

The kind of herbicides used may vary depending on the site of the traffic barrier, support or delineators. Certain herbicides will give temporary results by controlling existing vegetation only with no residual effects. This leaves the area vulnerable to annual weeds and grasses. Other herbicides can be added to reduce any regrowth. The residual period may vary according to the herbicide used, soil type, native vegetation and previous treatments.

Vegetation control around traffic barriers, supports, and delineators consists of using 2,4-D, glyphosate, Surflan either alone or in combination. 2,4-D and glyphosate are very soluble in water and require only mild agitation after mixing. Surflan is somewhat insoluble in water and requires vigorous and continuous agitation to prevent settling out.

Use 2,4-D and glyphosate only (no surflan) when site design dictates the possibility of lateral movement of the herbicide through the soil which can cause damage to adjacent desirable vegetation. This damage can occur when water flows from the pavement and shoulder over the treated strip and down a slope or where shrub beds exist adjacent to the treated strip.

When Surflan (soil residual) is used, only one application of this material is made in the spring and none shall be applied after July 1. Once this material has moved into the soil, there is very little danger of any serious lateral movement of the chemical. However, it should be pointed out that this material can be washed from the treated strip under certain conditions where a high volume of water moves across the treated area as discussed in the previous paragraph.

Method of Application

Sprayers of low pressure, low volume application are required. A 400 gallon sprayer is recommended for this operation and can be pulled by a dump truck which must

Vegetation Control Around Traffic Barriers

be equipped with a tachometer so accurate speeds can be maintained. Sufficient tank capacity is provided to treat four (4) acres before refilling.

When spraying traffic barriers, the following miles can be treated with 100 and 400 gallons of solution at 2.0 to 3.0 foot swaths:

	Miles	
	100 Gallons	400 Gallons
2.0 foot swath	4.2	16.5
2.5 foot swath	3.3	13.2
3.0 foot swath	2.8	11.0

When spraying around sign supports, 100 gallons of spray solution will treat at least 3,600 supports.

These units require limited special piping for a hand held nozzle boom. The solution is turned on and off with a hand operated ball valve from the bed of the dump truck.

Recommended Program

Treatment once a year for two (2) years is recommended with the use of herbicide combinations including soil residuals. If 2,4-D and glyphosate (non-soil residuals) are the only materials used, two (2) or more applications may be required at four (4) to six (6) week intervals. Re-treat with these materials only when green vegetation is present and growing. To accomplish the work, the spraying should begin by April 1 and be completed by September 15.

Precautions

The following should be observed when application is being done.

- Take every precaution to confine the spray pattern to the area to be treated. Stop all spraying when the wind is strong enough to carry the spray particles in droplet form **drift** away from the area being treated.
- Use as low a pressure and as large a nozzle tip as possible to reduce the possibility of **drift** damage. A drift control additive can be added to reduce the hazard of drift.
- Do not use soil residuals on recently completed construction projects to avoid erosion.
- Do not treat traffic barriers with soil residuals immediately adjacent to shrub beds.

Vegetation Control Around Traffic Barriers

- After soil residuals have been used, the equipment should be thoroughly flushed with water before spraying for broadleaf weed control and shrub bed weed control. Refer to page 52 for details on cleaning tanks.
- Avoid treating traffic barriers installed in ditches and supports located on slopes 3:1 and steeper.

Table 4

Control of Vegetation Around Traffic Barriers, Supports and Delineators Not Previously Treated With Soil Residuals

Vegetation to Control	Materials	Rate per Acre			Pressure	Time of Application
		Pounds	Liquid Measure	Water (gals)		
Thick, well established sod & deep rooted perennial broad-leaf weeds. ¹	Surflan AS (4 lbs/gal) +	4.0	1 gal	100	15-40	April thru June when vegetation is 6" or less.
	2,4-D (5.6 lbs/gal) +	1.9	1/3 gal			
	Glyphosate (4 lbs/gal)	4.0	1 gal			
The above treatment is considered the Basic Treatment						
Bermudagrass ²	Glyphosate (4 lbs/gal)	5.0	1-1/4 gal	100	15-40	May 15 to Sept. 15 (4 to 6 weeks) after basic treatment.
Vegetation at traffic barriers of new construction and areas adjacent to shrubs, or when soil residuals are not wanted. ⁴	2,4-D (5.6 lbs/gal) +	1.9	1/3 gal	100	15-40	April to Sept 15 when vegetation is 6" or less.
	Glyphosate (4 lbs/gal)	4	1 gal			

Notes: Can be found on page 2.25-2.26.

Vegetation Control Around Traffic Barriers

Table 5

**Control of Vegetation Around Traffic Barriers, Supports and Delineators Previously
Treated With Soil Residuals**

Vegetation to Control	Materials	Rate per Acre		Water (gals)	Pressure	Time of Application
		Pounds	Liquid Measure			
Thick well established sod & deep rooted broadleaf weeds. ¹	Surflan AS (4 lbs/gal)	3.0	¾ gal	100	15-40	April thru June when vegetation is 6" or less.
	+ 2,4-D (5.6 lbs/gal)	1.9	⅓ gal			
	+ Glyphosate (4 lbs/gal)	3	¾ gal			
The above treatment is considered the Basic Treatment						
Bermudagrass ²	Glyphosate (4 lbs/gal)	5	1-¼ gal	100	15-40	May 15 to Sept 16 (4 to 6 weeks) after basic treatment.
Vegetation at traffic barriers of new construction and areas adjacent to shrubs, or when soil residuals are not wanted. ³	2,4-D (5.6 lbs/gal)	1.9	⅓ gal	100	15-40	April 1 thru June when vegetation is 6" or less.
	+ Glyphosate (4 lbs/gal)	3	¾ gal			
Vegetation to be controlled by 2 to 5 gallon hand sprayers around supports and delineators. ⁴	Glyphosate (4 lbs/gal)	--	3 Tbs per gal of water	2-5	15-40	May 15 to June when vegetation is 12" or less.

NOTES:

¹ Surflan AS should never be dumped into an empty tank. This material must be added slowly to the water with medium to vigorous agitation. Maintain continuous agitation until application is completed. Completely resuspend before spraying continues.

Vegetation Control Around Traffic Barriers

NOTES CONTINUED:

² When grass is showing signs of recovering, Glyphosate is to be applied 4-6 weeks after basic treatment, up until September 15.

³ Repeat application 1 to 2 times at 4-6 week intervals if green vegetation is present.

⁴ Spray until solution is almost at point to drip from foliage.

Non-selective Grass & Broadleaf Weed Control

NON-SELECTIVE GRASS AND BROADLEAF WEED CONTROL (See Table 6 for Detailed Recommendations)

Objective

The primary objective of non-selective grass and broadleaf weed control is to reduce and eliminate the undesirable vegetation growing in pavement cracks, concrete barrier walls, highway shoulders and storage areas. Benefits such as control of noxious weeds, improved appearance and preservation of shoulders are obtained from this treatment.

Materials

The herbicides recommended are 2,4-D WSA and Glyphosate applied in water to the foliar vegetation during the active growing season.

Thorough mixing of this chemical combination with water is essential.

Method of Application

Sprayers capable of low pressure, high volume applications using vari-spacing Tee Jet Nozzles on a rear mounted boom, or Off-Center Nozzles have proven to be the most effective in obtaining coverage with a minimum hazard of drift.

Recommended Program

All highway shoulders where undesirable vegetation exists should be sprayed between April 15 and October 1, when the vegetation is green, actively growing and before it reaches a height of four (4) inches.

For most types of grasses and weeds, re-application may be required at two (2) to four (4) week intervals for optimum results.

Precautions

See Precautions “Broadleaf Weed Control”.

Non-selective Grass & Broadleaf Weed Control

Table 6

Weed Control In Pavement Cracks, Concrete Barrier Walls, Highway Shoulders and Storage Areas

Materials	Rate per Acre				Where Used	Time of Application
	Pounds	Liquid Measure	Water (gal)	Pressure		
* 2,4-D WSA (5.6 lbs/gal) + Glyphosate (4 lbs/gal)	1.9 4	$\frac{1}{3}$ gal 1 gal	50	15-40	Shoulders and cracks infested heavily with grasses and weeds where eradication will improve appearance and preserve shoulders.	April 15 to October 1.
2,4-D WSA (5.6 lbs/gal) + Glyphosate (4 lbs/gal)	1.9 5	$\frac{1}{3}$ gal 1 $\frac{1}{4}$ gal	50	15-40	Shoulders and cracks infested heavily with Bermudagrass (wiregrass), where eradication will improve appearance and preserve shoulders.	May 1 to October 1.

* Two to three applications of this combination of chemicals may be required to achieve maximum control at 2 to 4 week intervals.

Brush Control

INTRODUCTION

The growth of woody plants on the right-of-way can create hazardous highway conditions. Sight distance can be reduced, drainage ditches obstructed and traffic signs blocked from view. Chemical brush control can eliminate undesirable woody growth, adding to the safety and appearance of the highway. The Woody Vegetation Management Standard explains in more detail what woody vegetation needs to be controlled.

There are three methods of brush control in common use:

- Stem-foliage treatment
- Stump treatment
- Basal treatment

Stem-foliage treatment is limited to the growing season while the stump and basal treatments are limited to the period from October through April.

Stump treatment consists of cutting the brush and treating the cut stumps and stubble to prevent regrowth.



Brush Control

BRUSH CONTROL BY STEM FOLIAGE TREATMENT (See Table 7 for detailed Recommendations)

General

A stem foliage treatment may be conducted almost anytime it becomes necessary to control brush during the growing season. The best time to treat is between June and October, depending on plant species.

Avoid spraying any brush over three (3) feet in height, unless it is sprayed with Krenite S. If sprayed with Krenite S, brush should not be cut down for one year to obtain maximum results.



Materials

The herbicides used are 2,4-D plus Garlon 3A, or Krenite S alone. Thorough mixing of the chemical with water is essential. Continuous agitation is required.

Method of Application

Low pressure application is made by a hand held spray gun or Off-Center Nozzle, keeping the spray pattern close to the stems and foliage. Thoroughly wet the stems and foliage to the point of drip to obtain maximum control.

Precautions

Every effort must be made to reduce the possibility of causing damage to crops or plants outside of the areas to be sprayed. The following rules **must** also be observed when spraying brush:

- Carefully spray along roadsides in front of, or near houses, gardens or fields of **susceptible agricultural crops** during the growing season. These areas can be more safely treated during the dormant seasons of winter and early spring with a basal stem treatment.
- Use a low a pressure and as large a nozzle tip as possible, to give the desired coverage and to reduce the possibility of drifting.
- Stop all spraying when the wind is strong enough to carry spray particles in droplet form away from the area to be treated. Generally speaking, no spraying should be done when the wind exceeds five (5) MPH.

BRUSH CONTROL BY CUT STUMP TREATMENT (See Table 7 for Detailed Recommendations)

General

When brush, saplings, or small trees, are cut a stump treatment will be used to reduce suckering or resprouting. This treatment can be applied from October through April but must be conducted immediately after cutting to obtain maximum benefit. Within two hours for best results. There is very little possibility of causing damage to nearby vegetation with this method. This treatment is also very effective especially on species that tend to re-sprout vigorously such as black cherry, locust and mulberry. It should be followed by a Stem Foliage or Basal treatment the second year to spot-kill any re-growth that might occur.



Materials

The herbicides used are a ready-to-use (RTU) triclopyr ester (Pathfinder II), vegetable oil and a dye. When using this low volume treatment, the temperature is to be less than 70°F.

Method of Application

Application is made by a hand held low pressure spray gun, keeping the adjustable cone, Y-2 nozzle close to the stump. Occasionally, shake the backpack sprayer, while sprayer is in progress.

Remove litter such as sawdust, wood chips or leaves from the top and base of the stump before spraying. The treatment shall be made from the edge of the stump back to the cambium layer. The cambium layer is a narrow ring (light green) about ¼ to 1 inch back from the edge of the stump. Some chemicals should run down the sides of the stump on the exposed roots.

Precautions

Although there is little danger of damage due to drift of spray droplets from the confined type of application, the possibility is still present. Follow the precautions for stem foliage treatment.

Table 7

BRUSH CONTROL BY BASAL STEM TREATMENT (See Table 7 for Detailed Recommendations)

General

A basal treatment may be conducted when there is need to control brush in order to maintain sight distance for highway safety. This method should be used from October thru April except when snow or ice prevents spraying to the ground line. Tree of Heaven should be treated in August and September. Basal treatments applied during the dormant season can be used in treating areas close to susceptible crops such as legumes, grapes, etc., to reduce the possibility of damage. Treatment is conducted with a backpack sprayer equipped with a hand held nozzle.



Materials

The herbicide used is a ready-to-use (RTU) triclopyr ester, (Pathfinder II), a vegetable oil and a dye. When using this low volume treatment the temperature is to be less than 70°F or when treating Tree of Heaven less than 85°F.

Method of Application

Use a hand held spray gun at low pressure, keeping the Y-2 nozzle close to the trunk and stems. Thorough wetting and complete encircling up to a height of 20 inches above the ground surface to all trunks and stems of the plants to be killed **is essential**. All exposed roots should be treated, but no attempt should be made to spray tops of plants. Some herbicide should run down to the root crowns.

Precautions

Avoid high air velocities so danger of drift is reduced. In dormant applications follow the same precautions as listed in the stem foliage treatment.

Brush Control

Brush Control

Rate per Acre						
Materials	Pounds	Liquid Measure	Water (gal)	Pressure	Where Used	Time of Application
OR						
Stem Foliage Treatment ¹ 2,4-D (WSA) (5.6 lbs/gal) + Garlon 3A (3 lbs/gal)	1.9	1/3 gal	50 to 100	15-40	All Species	June thru Oct.
Krenite S ² (4 lbs/gal) + Dormant Oil	8	2 gal	100 to 150	40-150	No evergreens	August – Sept.
Stump ³ or Basal ⁴ Treatment Pathfinder II(RTU)*	*Premixed ready-to-use (RTU)			15-40	Tree of Heaven No evergreens	Oct. thru April August - Sept.

¹ Wet stems and foliage thoroughly. Density of brush will determine rate/acre; however, recommended gallons will cover one acre under normal conditions. More than one application may be necessary.

² Wet stems and foliage thoroughly. Density of brush will determine rate/acre; however, recommended gallons will cover one acre under normal conditions. Add 1 (one) quart of dormant oil per 100 gallons of solution.

³ Treat the cambium layer immediately by encircling the stump and cover all exposed roots. Density of stumps will determine rate/acre. Spot treatments of resistant species will be necessary the second year.

⁴ This treatment consists of encircling the lower 20 inches of each trunk. Some herbicide mix should run down to the root crown.

Tree of Heaven Control

TREE OF HEAVEN CONTROL

(See Table 7a for Detailed Recommendations)

General

Tree of Heaven is an aggressive and invasive tree. Tree of Heaven is also known as “Ailanthus”, “shumac” and “Chinese Sumac.” It has become a serious plant pest because it colonizes areas extremely quickly, crowds out native plants and can reach a height of over 60 feet. Trees spread by seeds and underground roots called rhizomes. Cutting Tree of Heaven will cause it to send up numerous shoots from the stump and from the rhizomes.

Objective

The objective of Tree of Heaven control involves eliminating the tree where it is growing and reseeding in the spring with appropriate grass or ground cover. In some instances the sites should be prepared for reforestation and/or landscaping. Herbicides must be used to control this species. Distinguishing Tree of Heaven from desirable species, especially sumac, is the first step in managing this species.

Identification

Tree of Heaven



Top: Leaves have smooth edges with one or two teeth at the base

Bottom: Papery seeds

Sumac



Top: Leaves have small teeth along edges

Bottom: Staghorn-cluster of seeds

Tree of Heaven Control

When controlling Tree of Heaven it is important to be aware of the presence of Sumac Trees and avoid spraying or cutting them. Sumac is a desirable native tree that is often confused with Tree of Heaven. There are other desirable trees such as Black Walnut and Hickory that also have similar characteristics.

Characteristics of Tree of Heaven

- Edges of leaves are smooth with 1 or 2 teeth at base.
- Tree has a pale yellow fall color that does not last long.
- Strong, objectionable odor from leaves and stems.
- Twisted papery seeds are green or pink in summer. Dry up into twisted, papery clusters in fall. Seeds can remain on trees through winter.
- Mature trees have smooth gray bark.
- Shield shaped leaf scars.

Characteristics of Sumac

- Leaves have small teeth along edge.
- Can have fuzzy twigs and stems.
- Orange or red fall color that can last for weeks.
- Can have large clusters of red seeds called a “Staghorn”.
- Horseshoe shaped leaf scars.

Materials

The best treatment is a basal stem herbicide of PathfinderII. This is a ready-to-use (RTU) product, containing a triclopyr ester, vegetable oil, and a dye. When using this low volume treatment the temperature is to be less than 85°F. Wait ninety (90) days before removing trees. Any resprouting should be treated with a stem foliar spray.

The foliar stem treatment herbicides are Krenite S plus dormant oil, or 2,4-D plus Garlon 3A. Thorough mixing of the chemical with water is essential. Continuous agitation is required.

Method of Application

Use a hand held spray gun at low pressure, keeping the Y-2 nozzle close to the trunk and stems. Thorough wetting and complete encircling up to a height of 20 inches above the ground surface to all trunks and stems of the plants to be killed **is essential**. All exposed roots should be treated, but no attempt should be made to spray tops of plants. Some herbicide should run down to the root crowns.

Low pressure application is made by a hand held spray gun or Off-Center Nozzle, keeping the spray pattern close to the stems and foliage. Thoroughly wet the stems and foliage to the point of drip to obtain maximum control.

Tree of Heaven Control

Precautions for Stem Foliar Treatment

Every effort must be made to reduce the possibility of causing damage to crops or plants outside of the areas to be sprayed. The following rules **must** also be observed when spraying brush:

- Carefully spray along roadsides in front of, or near houses, gardens or fields of **susceptible agricultural crops** during the growing season. These areas can be more safely treated during the dormant seasons of winter and early spring with a basal stem treatment.
- Use a low a pressure and as large a nozzle tip as possible, to give the desired coverage and to reduce the possibility of drifting.
- Stop all spraying when the wind is strong enough to carry spray particles in droplet form away from the area to be treated. Generally speaking, no spraying should be done when the wind exceeds five (5) MPH.

Precautions for Basal Stem Treatment

Although there is little danger of damage due to drift of spray droplets from the confined type of application, the possibility is still present. Follow the precautions for stem foliage treatment.

Tree of Heaven Control

Table 7a

Plant Size	Method	Material	Treatment Information
Height – Less than 15 ft.	Foliar	Fosamine <i>KreniteS</i>	A.I./ae: 4.0 lb/gal
			Rate: 10% fosamine plus 0.25% crop oil concentrate in water
			Time: August 15 – October 15 or full canopy coloration
			Remark s: Spray to wet – apply spray volume to thoroughly and uniformly cover the foliage without causing unnecessary run-off. Remove plant material, if necessary, during the following Spring.
		Caution: Apply no more than 24 lb AI fosamine per acre per year. Use a low pressure and coarse spray pattern to reduce spray drift to non-target species.	
		Triclopyr <i>Garlon4 and others</i> + 2,4-D	A.I./ae: Triclopyr - 4.0 lb/gal; 2,4-D – 3.8 lb/gal
			Rate: 0.05% triclopyr plus 0.05% 2,4-D in water
			Time: June 1 – September 30
Remark s: Spray to wet – apply spray volume to thoroughly and uniformly cover the foliage without causing unnecessary run-off. Remove plant material, if necessary, during the following Spring.			
Caution: Apply no more than 8.0 lb ae triclopyr per acre per year. Use a low pressure and coarse spray pattern to reduce spray drift to non-target species.			

Tree of Heaven Control

Table 7a continued

Height – Less than 15 ft.; trunk less than 6 in.	Basal Bark	Triclopyr (RTU) <i>Pathfinder II</i>	A.I./ae: 0.75 lb/gal
			Rate: Ready to use – no mixing required
			Time: August 1 – September 30
			Remark s: Apply with backpack sprayer using low pressure and solid cone or flat fan nozzle. Thoroughly wet the lower 12 to 15 in. of stems, including the root collar area, but not to the point of runoff. Wait at least 90 days before removing plant material.
Height – greater than 15 ft and/or Trunk - greater than 6 in.	Cut Stump	Triclopyr (RTU) <i>Pathfinder II</i>	Caution: Apply no more than 10.7 gal of solution per acre per year
			A.I./ae: 4.0 lb/gal
			Rate: 25% triclopyr in oil
			Time: August 1 – September 30
Height – greater than 15 ft and/or Trunk - greater than 6 in.	Cut Stump	Triclopyr (RTU) <i>Pathfinder II</i>	Remark s: Apply with backpack sprayer using low pressure and solid cone or flat fan nozzle. Thoroughly wet the lower 12 to 15 in. of stems, including the root collar area, but not to the point of runoff. Wait at least 90 days before removing plant material.
			Caution: Apply no more than 8.0 lb ae of triclopyr per acre per year
			A.I./ae: 0.75 lb/gal
			Rate: Ready to use – no mixing required
Height – greater than 15 ft and/or Trunk - greater than 6 in.	Cut Stump	Triclopyr (RTU) <i>Pathfinder II</i>	Time: Apply throughout the year, including winter months, except when snow or water prevent spraying to the ground line
			Remark s: Apply immediately after cutting to wet the area adjacent to the cambium and bark around the entire circumference and the sides of cut stumps. Thoroughly wet sides of stumps down to the root collar, but not to the point of runoff. Spot treatment of regrowth may be required during the following year.
			Caution: Control may be reduced from treatments made during periods of moisture stress (late summer)

Poison Ivy Control

POISON IVY CONTROL (See Table 8 for Detailed Recommendations)

Objective

The objective is to eradicate poison ivy in the right-of-way where contact could be made by our personnel and the public.

Material

The chemical recommended is 2,4-D WSA or Garlon 3A mixed with water. Thorough mixing is required but continued agitation is not required.



Method of Application

A hand held spray gun is used with sufficient pressure to thoroughly wet the foliage and stem to the point of runoff. A large droplet is preferred to a small droplet. Spot treatments the second year are necessary to ensure complete kill.

Recommended Program

This treatment is effective when made from May until the first frost. If the ivy is growing on desirable plants, cut the ivy at ground level in the winter and spray the sprouts in the following spring.

Precautions

See precautions on page 18 for 2,4-D. Garlon 3A is translocated through the leaves of most plants. Garlon 3A is not volatile, but one must follow all the precautions pertaining to drift.

The following rules should also be observed:

- Learn to recognize poison ivy.
- Use as large a nozzle and as low a pressure as possible to get thorough coverage.
- Do not spray when drift is carried to adjacent vegetation.

Poison Ivy Control

Table 8

Poison Ivy Control

Materials	Pounds	Rate per Acre		Pressure	Time of Application
		Liquid Measure	Water (gal)		
2,4-D (WSA) (5.6 lbs/gal)	3.8	½ gal	100	15-40	As soon as the poison ivy is in full leaf until the first frost in the fall.
Garlon 3A* (3 lbs/gal)	1	⅓ gal	100	15-40	As soon as the poison ivy is in full leaf until the first frost in the fall.

* The effectiveness of Garlon 3A is increased by adding a 1/2 pint of an agricultural surfactant to the mix.

Thistle Control

THISTLE CONTROL (See Table 9 for Detailed Recommendations)

General

A state law requires all Maryland property owners including SHA to prevent thistle seed development and the spread of seed to adjacent properties. Thistle growing on SHA right-of-ways creates a need for additional mowing due to the excessive summer growth and persistent complaints from adjacent property owners.



Objective

The objective of thistle control is to eradicate or control it on those areas of the right-of-way where it is growing.

Materials

The recommended herbicides are Transline, 2,4-D WSA, Garlon 3A, Velpar L or Vanquish. These herbicides can be used as a broadcast application in turf areas. Transline is the preferred herbicide for spot treatment; however, it should not be used where trees and shrubs with shallow roots are growing. Velpar L is to be used in crownvetch areas only.



Method of Application

The recommended method of application is by hand-controlled spray gun or a fixed nozzle to thoroughly wet the foliage. Repeat treatments are required to obtain a complete control.

Recommended Program

These treatments are effective when the plants are young, 5 to 10 inches in height and before flowering (April 15 to September 31). When thistles are in flower, the plants should be mowed and a chemical treatment made upon foliar regrowth.



Thistle Control

Precaution

Transline, Garlon 3A, Vanquish and Velpar L are non-volatile; therefore, the only source of damage to vegetation adjacent to the spraying operation is by the drift of spray droplets or direct contact with the spray.

The following rules should be observed:

- Learn to recognize thistles and confine spraying to these plants.
- Use as large a nozzle and as low a pressure as possible to get thorough coverage.
- Do not spray when the wind is “drifting” the fine spray droplets to nearby vegetation.
- Re-spray as directed in Table 9.
- Spray before thistles go to flower.



Thistle Control

Table 9

Thistle Control

Materials	Rate per Acre			Pressure	How Used and Time of Application
	Pounds	Liquid Measure	Water (gal)		
2,4-D (WSA) (5.6 lbs/gal) + Garlon 3A* (3 lbs/gal)	1.4 1.0	¼ gal ⅓ gal	100	15-40	Treat when plants are 5-10" in height, re-treat in 6-8 weeks.
Vanquish (4 lb/gal)	0.75	1½ pints	100	15-40	Treat when plants are 5-10" in height. Usually need to treat once per year.
Transline (3 lbs/gal)	0.38	1 pint	100	15-40	Treat when plants are 5-10" in height. Usually need to treat once per year.
2,4-D (WSA) (5.6 lbs/gal) + Transline (3 lbs/gal)	0.7 0.16	1 pint ½ pint	100	15-40	Treat when plants are 5-10" in height. Usually need to treat once per year.
Velpar L (2 lbs/gal)	0.38	1½ pints	100	15-40	Treat only once per year in crownvetch areas only when thistle plants can be seen.

* The effectiveness of Garlon 3A is increased by adding a ½ pint of an agricultural surfactant per 100 gallons of mix. When using Garlon 3A use a ½ pint of drift control per 100 gallons of mix. Thistle in flower must be mowed before chemical treatment is made.

Weed Control in Shrub Beds

WEED CONTROL IN SHRUB BEDS (See Table 10 for Detailed Recommendations)

Objective

The objective of this treatment is to eliminate all undesirable weed growth in shrub beds.

Materials

The kind of herbicides used vary with the type of vegetation to be controlled and the time of application. Certain herbicides are applied in a water solution while others are applied in a dry granular form. Some herbicides are applied when the weeds and shrubs are dormant. SHA's program is based on the use of glyphosate, Surflan AS, Dichlobenil 4G, Ronstar 2G or Snapshot 2.5 TG to achieve economical control of undesirable vegetation.



Method of Application

Sprayers equipped with a handgun containing a single TeeJet Nozzle, capable of delivering low pressure and low volume applications are required. Large spray droplets are required to avoid drift to susceptible plants.

A hand held rope wick applicator can also be used for glyphosate.

For applying the granular herbicides, a rotary or cyclone applicator is required to distribute the herbicide material evenly over the mulch surface.

Recommended Program

To obtain maximum weed control in shrub beds, more than one treatment is required. In the winter (November 10 to March 1) an application of granular pre-emergence herbicide is made. Beginning in May, a combination of a preemergent and postemergent herbicide treatment is required to control annual and perennial grasses and broadleaf weeds such as crabgrass, ragweed and lambsquarter. If any weeds persist, a re-treatment is required four (4) weeks later.

Precautions

All of the herbicides referred to above are non-volatile except Dichlobenil 4G. All the above mentioned herbicides can be used safely if the precautions below are observed when applying.

Weed Control in Shrub Beds

Glyphosate

- Take every precaution to confine the spray pattern to existing weed growth and away from shrubs.
- Use as low as pressure and as large a tip or nozzle as possible to reduce the possibility of “drift” damage.
- Apply herbicides when the weed growth is three (3) to six (6) inches in height.
- Stop all spraying when wind is “drifting” the fine spray droplet to off target vegetation.
- The rope wick applicator can be used.

Surflan AS

- Maintain continuous agitation until application is completed.
- Settled materials in the spray tank must be re-suspended before spraying continues.
- Take every precaution to confine the spray pattern to existing weed growth and away from shrubs.
- Use as low a pressure and as large a tip or nozzle as possible to reduce the possibility of “drift” damage. Stop all spraying when wind is “drifting” the fine spray droplet to off target vegetation.
- Surflan AS stains, be careful when spraying around structures.

Dichlobenil 4G or Ronstar 2G or Snapshot 2.5TG

- Make only one application per year.
- Herbicides shall be applied between November 10 and March 1 to the surface of the mulch. Herbicides may be applied between March 15 and November 15 if covered immediately with a three (3) inch mulch layer.
- Herbicides shall be applied uniformly over the area to be treated.
- Areas greater than ten (10) feet in width shall have the application split so one half of the material is applied in a direction parallel to the length of the bed and the other half of the material applied in a direction to the width of the bed.
- The herbicides shall be confined within the limits of the plant bed or plant pit during application.

Weed Control in Shrub Beds

- Do not apply when mulch or ground is frozen to prevent movement into turf areas.
- Contact the Landscape Operations Division before treatment to determine if bulbs are present or if bulbs are scheduled for planting in the shrub beds.

Table 10

Control Of Weeds In Shrub Beds

Materials	Rate per Acre				Pressure	Time of Application
	Dry Measure	Pounds	Liquid Measure	Water (gal)		
<u>Granular</u>						
Dichlobenil 4G*	125 to 150 lbs	--	--	--	--	Nov. 15 to March 1
OR						
Ronstar 2G*	100 to 200 lbs	--	--	--	--	March 1 to May 1
OR						
Snapshot 2.5TG*	100 to 200 lbs	--	--	--	--	March 1 to May 1
<u>Spray</u>						
Glyphosate (4 lbs/gal) +	--	5.0	1 ¼ gal	100	15-20	May 1 to Sept. 30
Surflan AS ** (4 lbs/gal)	--	4.0	1 gal			May 1 to July 1
<u>Rope Wick</u>						
Glyphosate (4 lbs/gal)	--	1.0	1 quart	3 quarts	--	May 1 to Sept. 30

* The specific rate shall be determined by the Landscape Operations Division based on existing soil types, shrub types and previous treatments and results.

** Add Surflan AS slowly to the water with continuous agitation. Agitate until application is completed. Settled materials must be completely resuspended before spraying continues.

Vegetation Control Prior to Paving

VEGETATION CONTROL PRIOR TO PAVING

(See Table 11 for Detailed Recommendations)

Objectives

The primary objective of this treatment is to reduce and prevent undesirable vegetation from growing through shoulders. Benefits such as preservation of pavement and tar and chip shoulders, control of weeds and improved appearance are obtained from this treatment.

Materials

The herbicides recommended are either Hyvar X-L or Pramitol 25 E applied in water to the area to be surface treated.

Thorough mixing of the chemical with water is essential and continuous agitation is required when Pramitol 25 E is used.

Method of Application

Sprayers capable of low pressure, high volume applications using broadcast TeeJet or Off-Center Nozzles have proven to be the most effective in obtaining coverage with a minimum hazard of drift.

Recommended Program

All highway shoulders should be sprayed when undesirable vegetation exists or is expected to occur after the surface treatment. Application must be made within one half (1/2) hour prior to the paving or surface treatment.

Precautions

All areas sprayed must be paved or surface treated within one half (1/2) hour, otherwise, rain and traffic will cause the herbicides to move from the treated areas to the established vegetation (grass, trees, and shrubs) adjacent to the shoulder. The desirable vegetation will be severely injured if it comes in contact with these herbicides. This must be avoided. Leave at least one (1) foot of pavement or shoulder next to the desirable vegetation untreated with the herbicide.

Vegetation Control Prior to Paving

Table 11

Vegetation Control Prior to Paving

Materials	Pounds	Rate per Acre		Pressure	Where Used	Time of Application
		Liquid Measure	Water (gal)			
Hyvar X-L (2 lbs/gal)	8-24	4-12 gals	50	15-40	Prepaving areas, where eradication of weeds will improve and preserve pavements and shoulders.	March 1 to Oct. 31
OR						
(1) Pramitol 25 E (2 lbs/gal)	15-30	7.5-15 gals	50	15-40	Prepaving areas, where eradication of weeds will improve and preserve pavements and shoulders.	March 1 to Oct. 31

(1) Continuous agitation is required when Pramitol 25 E is used.

Wirestem Control

WIRESTEM MUHLY CONTROL (See Table 12 for Detailed Recommendations)

General

Wirestem Muhly growing on the right-of-way creates additional mowing due to its excessive growth during summer months and crowds out desirable grasses.



Objective

The objective of Wirestem Muhly control is to eradicate it from our right-of-way and prevent its spread to adjacent property.

Materials

The recommended herbicide is glyphosate.

Method of Application

This application requires a low volume gravity flow rope wick boom saturated with glyphosate. The herbicide makes contact with the leaves of Wirestem Muhly by the rope wick boom passing over and rubbing the leaves at 2.5 to 5 MPH.

Recommended Program

These treatments are effective when the Wirestem Muhly is eight (8) inches or more above the desired turf.

Precautions

Glyphosate will control all the grass that it comes in contact with. Avoid rubbing plants other than Wirestem Muhly.

The following rules should be observed:

- Learn to recognize Wirestem Muhly.
- Use rope wick on level land.

Wirestem Control

- The lowest wick contact point with Wirestem Muhly should be no less than two (2) inches above desired turf.
- Use only clean water for mixing.
- The reservoir vent cap should be loosened to prevent vacuum lock.
- Maximum rope saturation should be maintained to provide no more than an occasional drip.
- Wash wicks with strong stream of water after each use.

Table 12

Wirestem Muhly Control

Material	Pounds	Rate per Acre		Pressure	Time of Application
		Liquid Measure	Water (gal)		
Glyphosate (4 lbs/gal)	4.0	1 gal 2 parts water to 1 part Glyphosate	2	Gravity fed no pressure	When Wirestem Muhly is 8" or more above desired turf, late June thru August.

Johnsongrass Control

JOHNSONGRASS CONTROL (See Table 13 for Detailed Recommendations)

General

A Maryland State Law declares Johnsongrass a “noxious weed” and requires all landowners to prevent this plant from going to seed and spreading to others properties. Johnsongrass growing on the right-of-way creates additional mowing due to its excessive growth during the summer months.



Objective

The objective of Johnsongrass control is to eradicate Johnsongrass from our right-of-way or prevent Johnsongrass seed and rhizomes contaminating property adjacent to our rights-of-way.

Material

The recommended herbicide is glyphosate.

Method of Application

The recommended method of application is by a hand held gun using adequate pressure to thoroughly wet the foliage and stems.



Recommended Program

This treatment is effective June 15 to October 1 when the plants are 1 to 5 feet in height and not in seed.

Precautions

Glyphosate is non-volatile; therefore, the only source of damage to vegetation adjacent to the spraying operation is by drift of spray droplets or direct contact with the spray.

The following rules should be observed:

- Learn to recognize Johnsongrass and confine your spraying to this single plant; therefore, spot spray.

Johnsongrass Control

- Use as large a nozzle and as low a pressure as possible to get thorough coverage.
- Do not spray when the wind is “drifting” the fine spray droplets to nearby vegetation.
- Spray before Johnsongrass goes to seed.

Table 13

Johnsongrass Control

Material	Pounds	Rate per Acre		Pressure	Time of Application
		Liquid Measure	Water (gal)		
Glyphosate (4 lbs/gal) (Spot Spraying)	4	1 gal	50 to 100	15-40	June 15 to October 1 when vegetation is 24-48” in height. Re-spray at 4 weeks intervals.

Phragmites Control

PHRAGMITES CONTROL (See Table 14 for Detailed Recommendations)

General

A Maryland State Law declares Phragmites a “nuisance weed.” It crowds out native species, (especially desirable wetland plants). Phragmites has little benefit to wildlife and MDOT is required to control it on its right-of-ways. Phragmites is an aggressive, invasive weed, which grows 10-13 feet in height, spreads mostly by thick, fleshy roots called rhizomes, and is hard to kill by mechanical means. It usually grows in damp areas, but not in standing water.



Objective

The objective of Phragmites control on SHA right-of-way is to reduce drainage problems, prevent sight distance obstruction and sustain desirable wetland vegetation. Its control is also used for mitigation in wetlands which includes flowing, tidal, intermittent, and 100 year floodplains.

Special Requirements

The use of chemical control methods in wetland areas requires a permit from the Maryland Department of Environment. The permit “Request for Permission to Use Toxic Materials for Aquatic Life Management Purposes” must be obtained prior to the beginning of spray operations. Permits are usually valid for two years.

Permission to apply herbicides are to be made by June 1st to the:

Director, Office of Environmental Design
707 N. Calvert Street Mailstop C-303
Baltimore, Maryland 21202
Telephone No. (410) 545-590

The current criteria for granting permission includes:

- Sites must be identified by size and be located on map.
- Individual who supervises the application must have pesticide certification for Category V (Aquatic). Contact LOD for assistance.
- Purpose of project must be specified as wetland mitigation, or to facilitate drainage.
- Re-vegetation Management Plan must be specified as natural succession, monitoring, and re-treatment or burning, replanting, monitoring, and re-treatment.

Phragmites Control

Materials

Aquatic glyphosate, in combination with an aquatic wetting agent, is the only herbicide which is to be used for Phragmites control.

Method of Application

Application should be made selectively to Phragmites by a hydraulic or backpack sprayer, to thoroughly wet foliage. Dense stands of Phragmites should be sprayed from opposite sides where possible, to avoid “shadowing” of spray.

Recommended Program

The time of application for effective control is late summer till early fall, when plants are mature with flower heads, but before a killing frost. Results are slow to show and re-spraying is frequently necessary the following year.

Precaution

Do not spray site without a permit.

Table 14

Phragmites Control

Materials	Rate per Acre			Pressure	Time of Application
	Pounds	Liquid Measure	Water (gals)		
Aquatic glyphosate * (5.4 lbs/gal)	3	$\frac{3}{4}$ gal	100	30-40	August 15 to October 15 when plants are of mature height, with flower head, but before a killing frost.
+ Aquatic surfactant (wetting agent)		2 quarts			

*** Do not spray site without a permit.** Spray to thoroughly wet foliage, but not to drip.

Spraying Equipment

SPRAYING EQUIPMENT OPERATION AND MAINTENANCE

There are certain general procedures in equipment operation and maintenance, that apply to every piece of spraying equipment and certain methods of application, that have proven practical and effective. The detailed setup for each particular operation shall be supervised by the certified pesticide supervisor.

EQUIPMENT OPERATION

Safety

Application of herbicides on the highway right-of-way is done at relatively low speeds. Since a slow moving vehicle is a traffic hazard, the importance of warning lights, arrow panels, and signs cannot be over-emphasized.

Filling Tanks

- Shut off discharge nozzles.
- Determine amount of water for acreage requiring treatment.
- Add three-fourths ($\frac{3}{4}$) the total amount of water required. Ensure anti-siphoning devices or procedures are in place.
- Open by-pass and agitation lines to insure proper mixing of materials.
- Calibrate sprayer by determining spray output at nozzle and using formula on page 2.72.
- Add required chemicals.
- Bring solution level up to desired point.
- Operate pump according to manufacturer's operating instructions. Do not operate pump without liquid.

Cleaning Tank

Throughout the spraying season, it may become necessary to thoroughly clean the spraying system. When any of the following conditions prevail, the spraying system must be cleaned with a cleaning solution.

- When changing from one type of herbicide to another examples include:
 - Changing from non-selective to selective herbicides.
 - Changing from residual to non-residual and/or selective herbicides.
- Cleaning and storing for short periods of time and over winter.

Spraying Equipment

Some herbicides are used with an oil carrier. When wettable powders, dry flowables, and some soil residuals are added to a tank, which has not been properly cleaned, a chemical reaction takes place in which the chemical “settle out” in a heavy mass similar to putty. To prevent this from occurring, clean the spraying system by following the procedures listed below:

- Spray out the tank until empty on an approved target.
- Flush thoroughly with water and spray out also on an approved target.
- Add the following amount of water and cleaning solution per 400 gallons of tank size:

Material	Pounds	Quarts	Gallons of Water
Nutrasol	2.0	--	100
OR			
Household Ammonia		1	25

- Observe all manufacturers’ precautions regarding use of above materials.
- Agitate the system for 15 minutes, clean all nozzles and screens with a soft brush. Use spray gun nozzle to flush walls of spray tank.
 - **Note:** When hormone/auxin type herbicides such as 2,4-D and Garlon are used, allow cleaning solution to remain in spray system overnight.
- Drain cleaning solution on an approved target and rinse all systems well with 20-50 gallons of water for 10 minutes.
 - **Note:** When hormone/auxin type herbicides as listed above are used, rinse twice with water.

EQUIPMENT MAINTENANCE

The following information is intended only as a guide. For detailed information, consult the instruction manual provided with the spray unit.

Engine

Keep air cleaner and cooling system clean and change oil in accordance with manufacturer’s recommendations.

Spraying Equipment

Centrifugal Pump

- Pump bearings were packed and sealed at the factory and require no further attention.
- Check pump oil level at each engine oil change. Add S.A.E. 30 as needed.

General Care of Sprayers

- Keep all nuts, bolts, and screws tight.
- Remove and clean suction strainer periodically, daily if using insoluble materials such as Surflan AS or other insoluble chemicals.
- Any oil or water leakage should be corrected immediately.
- If the unit is stored between operations during the season, it should be flushed out after last use.
- For winter storage drain tank, lines, valves and pump completely. An environmentally safe antifreeze placed in the pump will protect it during storage. See instruction's manual for further details.
- Check equipment thoroughly and make necessary changes, repairs or adjustments, prior to the beginning of the spraying season to avoid delays in the spray program.
- Make sure the liquid sight gauge is clear and tank capacity tape is readable in order to accurately measure the solution in the tank.

Trouble Shooting

- No delivery at nozzles
 - Tank empty or vent closed
 - Nozzle tips, screens, hoses, or strainers clogged
 - Improper mixing
 - Pump failure
 - Low pressure
- Fluctuating Pressure
 - Low liquid level, vortexing
 - Nozzle tips, screens, hoses, or strainers clogged
- Starved Pump
 - Suction strainer clogged
 - Suction hose collapsed or leaking
 - Lack of prime

Spraying Equipment

EQUIPMENT FOR BROADLEAF WEED CONTROL AND APPLICATION OF PLANT GROWTH REGULATORS

General

The four sizes of equipment recommended for weed control are the 400, 1,500, 2000 and 3,000 gallon sprayers. The 400 gallon sprayer can be used quite effectively for treatment of narrow roadsides, shoulders, and around posts. The 1,500, 2,000 and 3,000 gallon sprayers are designed for large acreages of interchanges, roadsides and medians.

A problem in broadleaf weed control is applying a given amount of herbicide at a reasonable speed on varying widths of right-of-way with the topography changing from level to steep cuts and fills. There is no simple solution to this problem; however, a well trained herbicide applicator can achieve a satisfactory job.

In general, a three to five nozzle system as illustrated in Drawing 1, and controlled by switches or valves near the position of herbicide applicator, has proven satisfactory. This system allows the applicator to select the desired spray width to meet the particular roadside situation.

When applying broadleaf weed control chemicals or plant growth regulators to traffic barriers, a system as illustrated in Drawing 2 must be used in order to obtain the desired results.

POWER SPRAYING UNIT (400 GALLON UNIT)

At the present time the sprayer recommended is the 400 gallons Pumping Systems Sprayer (Drawing 3), or an approved equal.

The unit can be used for the following application: application of herbicides for both weed and brush control, and plant growth regulators for grass control.

The unit is trailer drawn, but a skid-mounted unit may be available. Specifications for the main components include the following components.

Tank

The tank has a capacity of 400 gallons and is made from fiberglass. There is an air gap between the fill line and the tank to prevent back flow of herbicide solution into the water supply.

In order to permit proper servicing and cleaning of the tank, access is provided to allow an average size person, to enter the tank via a safety lid.

Tank agitation is accomplished by use of a full length sparging tube. Generally the tube is 1" to 2" diameter pipe with 1/32 to 1/16" holes drilled on six (6) inch centers throughout the length of the pipe placed in the bottom of the tank. The holes in the sparging tube need to be directed so the agitation discharge is directed towards the bottom of the tank.

The suction line installed in the bottom of the tank is equipped with an anti-vortex fitting in order for all solution to be drawn from the tank.

Spraying Equipment

Pump

The pump recommended is a single stage centrifugal self-priming pump. The pump is fitted with a ceramic shaft seal, is fluid lubricated and corrosion resistant. The pump has a 2" suction and 1-1/2" discharge with a performance to equal or exceed 150 G.P.M. at 40 P.S.I. Pump is equipped with a 0 to 60 PSI oil-filled pressure gauge.

Power Unit

The power unit consists of an 8.0 horsepower cast iron sleeved engine with a recoil starter and four (4) gallon gas tank. The power unit has adequate power for pump performance.

Nozzle Arrangement

The nozzle arrangement consists of a four (4) ball valve cutoff system (tail gate mounted), three (3) Off-Center nozzles and a rear mounted boom equipped with five (5) Tee Jet nozzles.

Drawing No. 1 Off-Center Nozzle Spray Pattern

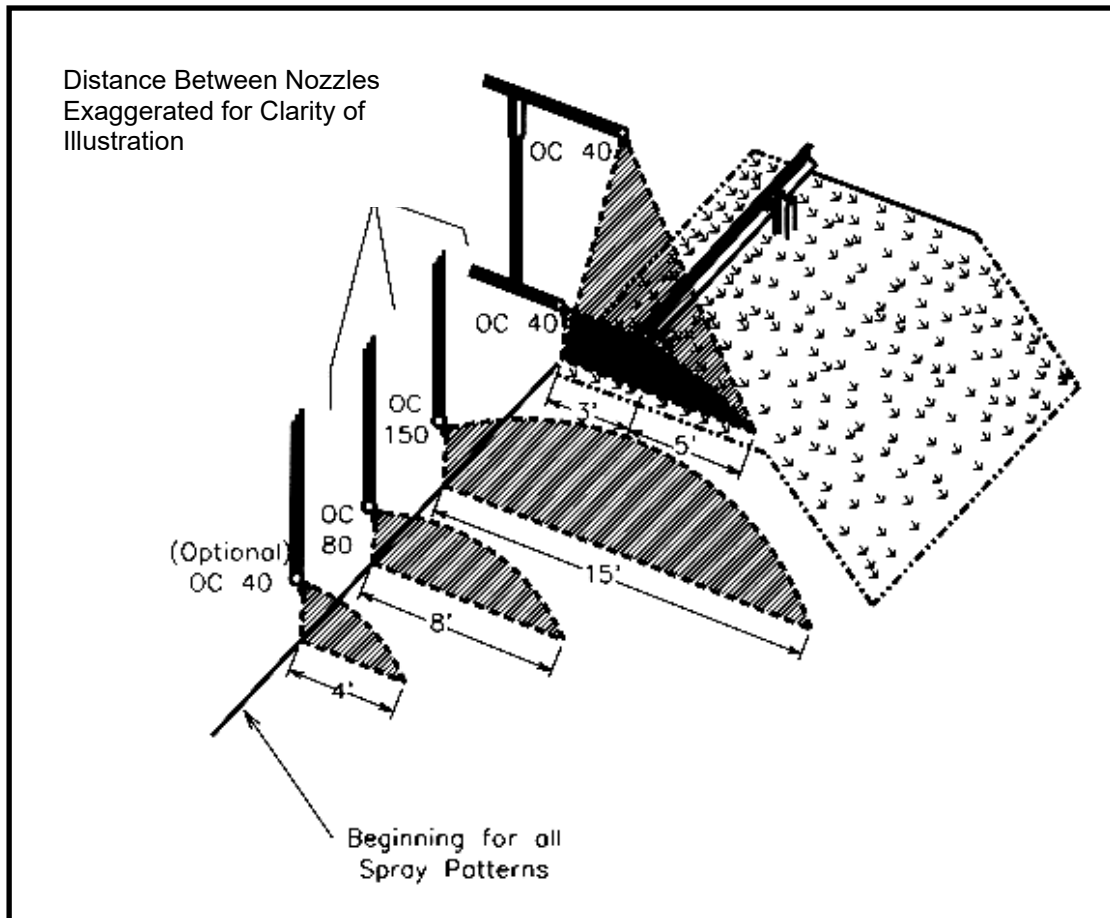

Weed Control Using The Four Nozzle System In Conjunction With The PGR And 2,4-D Traffic Barrier Applicator

Spraying Equipment

**Drawing No. 2 Nozzle Arrangement 400 Gallon Roadside Herbicide Sprayer
Front View**

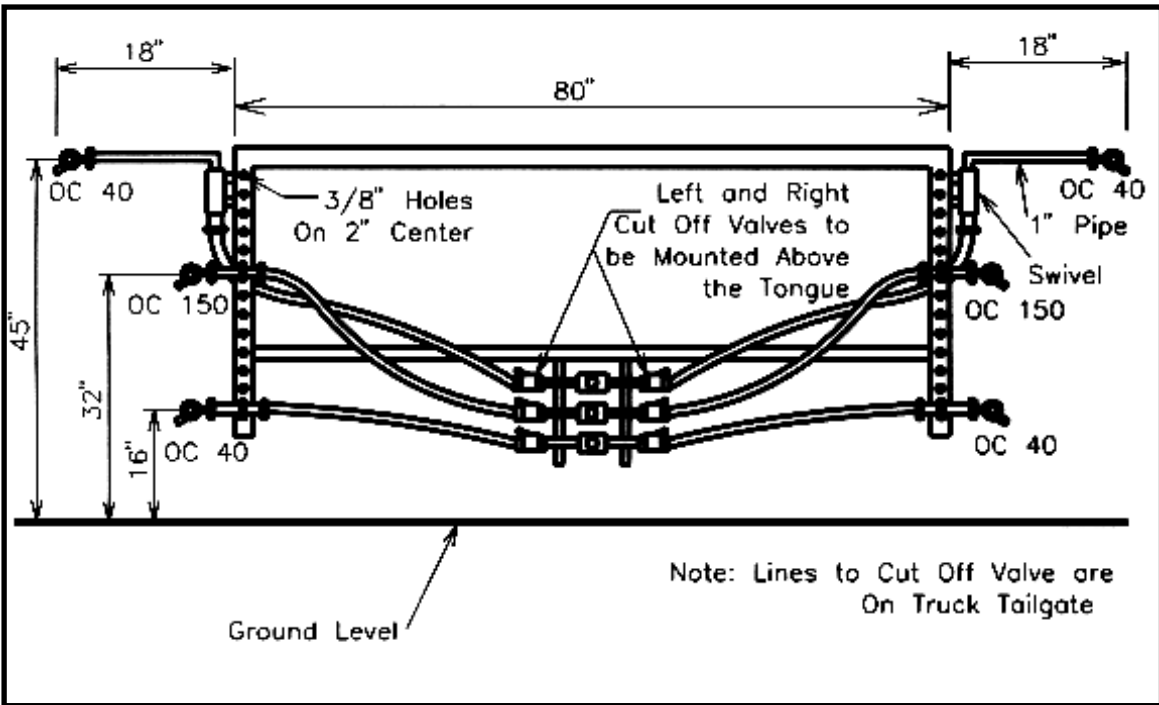

**Drawing No. 3 Components of a Roadside Sprayer
Side View**

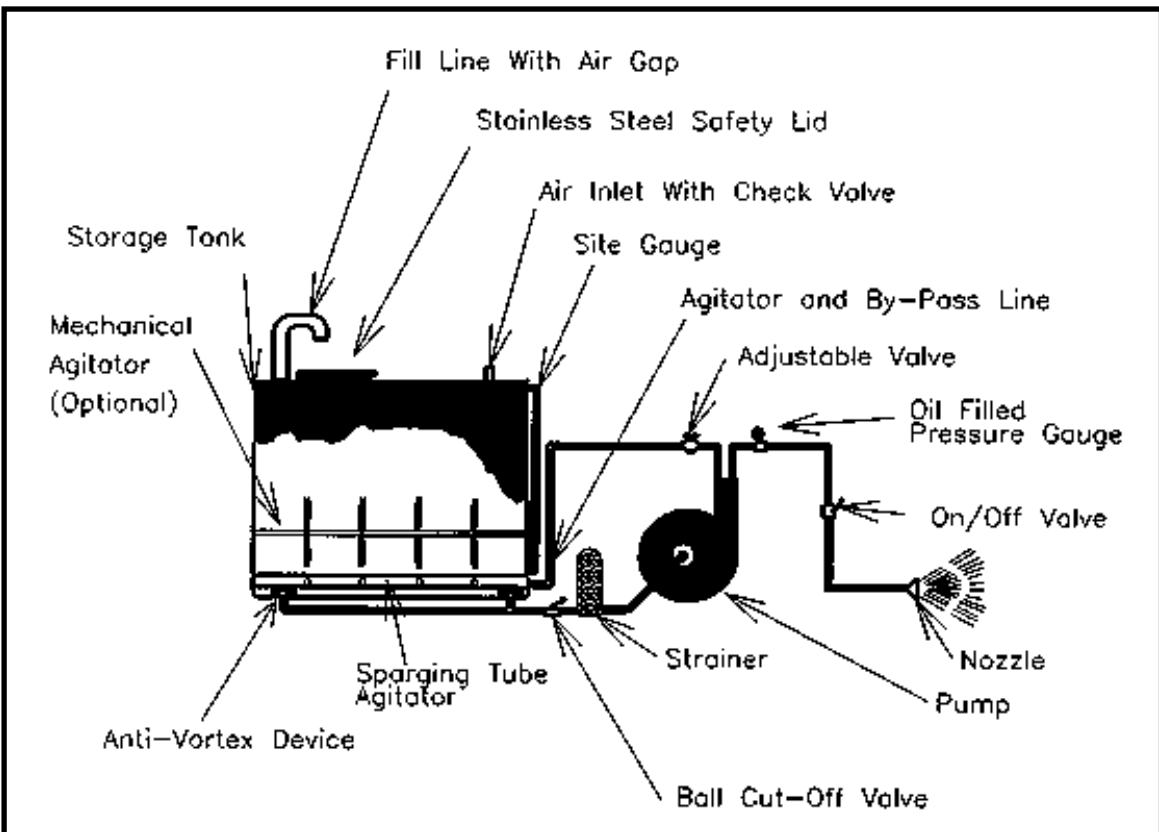

GPM Table

Table 15

Gallons Per Minute for Broadleaf Weed Control and PGR Application

	Spray Swath in Feet							
	2.5	5	8	10	15	20	25	
MPH	Required Gallons per Minute to Give 50 Gals. per Acre							
3	0.75	1.5	2.4	3	4.5	6	7.5	
3.5	0.88	1.8	2.8	3.5	5.3	7	8.8	
4	1.1	2	3.2	4	6.1	8.1	10	
4.5	1.1	2.3	3.6	4.5	6.8	9.1	11.4	
5		2.5	4	5	7.6	10.1	12.6	
5.5		2.8	4.4	5.6	8.3	11.1	13.9	
6		3	4.8	6.1	9.1	12.1	15.2	
6.5		3.3	5.3	6.6	9.8	13.1	16.4	
7		3.5	5.7	7.1	10.6	14.1	17.7	
7.5		3.8	6.1	7.6	11.4	15.2	18.9	
8		4	6.4	8.1	12	16.2	20.2	
8.5		4.3	6.7	8.6	12.9	17.2	21.5	
9		4.5	6.9	9.1	13.6	18.2	22.7	
9.5		4.8	7.7	9.6	14.4	19.2	24	
10		5.1	8.1	10.1	15	20.2	25.3	
15		7.6	12.1	15.1	22.7	30.2	37.8	
		Required Gallons per Minutes to Give 40 Gal. per Acre						
10		4	6	8	12	16	20	
12.5		5	8	10	15	20	25	
15	6	10	12	18	24	30		

Acres Per Mile Table

Table 16

Number of Acres per Mile for Various Spray Widths

Spray Width (Feet)	Acre Per Mile
2.5	0.3
3	0.4
5	0.6
8	1.0
10	1.2
15	1.8
20	2.4
25	3.0
30	3.6
40	4.8
50	6.1
60	7.3
70	8.5
80	9.7
90	10.9
100	12.1
110	13.1
120	14.5

GPM for OC Tips Table

Table 17

Gallons per Minutes for 3/4" OC Nozzle Tips

OC Tip	Pressure PSI	Capacity In GPM
OC 10	20	0.71
	30	0.87
	40	1.00
OC 20	20	1.40
	30	1.70
	40	2.00
OC 40	20	2.80
	30	3.50
	40	4.00
OC 80	20	5.60
	30	7.00
	40	8.00
OC 150	20	10.60
	30	13.00
	40	15.00
OC 300	20	21.20
	30	26.00
	40	30.00

Table 18

Feet Travels in 30 Seconds Converted to MPH

Feet Traveled in 30 seconds	MPH	Feet Traveled in 30 seconds	MPH
44	1.0	273	6.2
66	1.5	281	6.4
88	2.0	286	6.5
97	2.2	290	6.6
106	2.4	299	6.8
110	2.5	308	7.0
114	2.6	317	7.2
123	2.8	326	7.4
132	3.0	330	7.5
141	3.2	334	7.6
150	3.4	343	7.8
154	3.5	352	8.0
158	3.6	361	8.2
167	3.8	370	8.4
176	4.0	374	8.5
185	4.2	378	8.6
194	4.4	387	8.8
198	4.5	396	9.0
202	4.6	405	9.2
211	4.8	414	9.4
220	5.0	418	9.5
228	5.2	422	9.6
238	5.4	431	9.8
242	5.5	440	10.0
246	5.6	462	10.5
255	5.8	550	12.5
264	6.0	660	15.0

Travel Time Table

Table 19

**Time Required to Travel
One Mile at Various Speeds**

MPH	Minutes	Seconds
1.0	60	----
2.0	30	----
3.0	20	----
3.5	17	8
4.0	15	----
4.5	13	20
5.0	12	----
5.5	10	54
6.0	10	----
6.5	9	14
7.0	8	34
7.5	8	----
8.0	7	30
8.5	7	3
9.0	6	40
9.5	6	19
10.0	6	----
11.0	5	27
12.0	5	----
12.5	4	48
13.0	4	37
14.0	4	17
15.0	4	----
20.0	3	----

Spraying Equipment

EQUIPMENT FOR CONTROL OF VEGETATION AROUND TRAFFIC BARRIERS, SUPPORTS AND DELINEATORS

General

Application of herbicides is to be confined to a strip with a maximum width of thirty-six (36) inches, eighteen (18) inches on either side of the center of the traffic barriers. When spraying around sign supports treatment is not to exceed an area 2.5 feet wide by 4.5 feet long.

The major type of equipment recommended is the 400 gallon sprayer. This sprayer is to be towed behind a one to five ton dump truck equipped with an engine tachometer, so that accurate application ground speeds can be maintained. This sprayer can carry sufficient spray material to operate all day without refilling.

The major problem when applying herbicides under the traffic barriers and around sign supports, is to confine the spray pattern to the area to be treated. The problem is further complicated by varying heights, types of traffic barriers and the locations of signs in relation to the roadway. To date, no one system has been developed that is completely satisfactory in applying a controlled spray pattern under all types of traffic barriers and around individually located sign supports and delineators. The application system described below has given good results and is to be used.

Hand Controlled Spray Boom

Herbicides can be effectively applied around traffic barriers by the use of a hand held and hand controlled spray boom. Some method of support for the spray boom may be provided, so the nozzle can be positioned without a constant strain on the applicator.

The method described below has given very good vegetation control:

- Dual Flat Spraying Systems ¼" 6510 or 6515 Nozzles Held in Front and Behind the Traffic Barriers (See Drawing 4).

The nozzles are held about twelve (12) inches above the ground level and angled so the pattern falls in the proper position under the traffic barriers. The angle and height of the nozzles control the width of the spray pattern. This system gives good control of vegetation in front and behind the traffic barriers.

Spraying Equipment

Table 20

**Reference Table to Determine Miles per Hour For
Control of Vegetation around Traffic Barriers**

Gallons per Minute	MPH	Feet per 30 Seconds	Gallons per Minute	MPH	Feet per 30 Seconds
1.02	2.0	88	1.92	3.8	167
1.26	2.5	110	1.96	3.9	172
1.32	2.6	114	2.02	4.0	176
1.36	2.7	119	2.08	4.1	180
1.42	2.8	123	2.12	4.2	185
1.46	2.9	128	2.18	4.3	189
1.50	3.0	132	2.22	4.4	194
1.56	3.1	136	2.28	4.5	198
1.62	3.2	141	2.32	4.6	202
1.66	3.3	145	2.38	4.7	207
1.72	3.4	150	2.42	4.8	211
1.76	3.5	154	2.48	4.9	216
1.82	3.6	158	2.52	5.0	220
1.86	3.7	163	2.56	5.1	224

Note: Figures in this Table are based on two and one half (2.5) foot swath at 100 gallons per acre.

Spraying Equipment

Drawing No. 4
Dual 1/4" 6510 or 6515 Nozzles Held Around Traffic Barrier

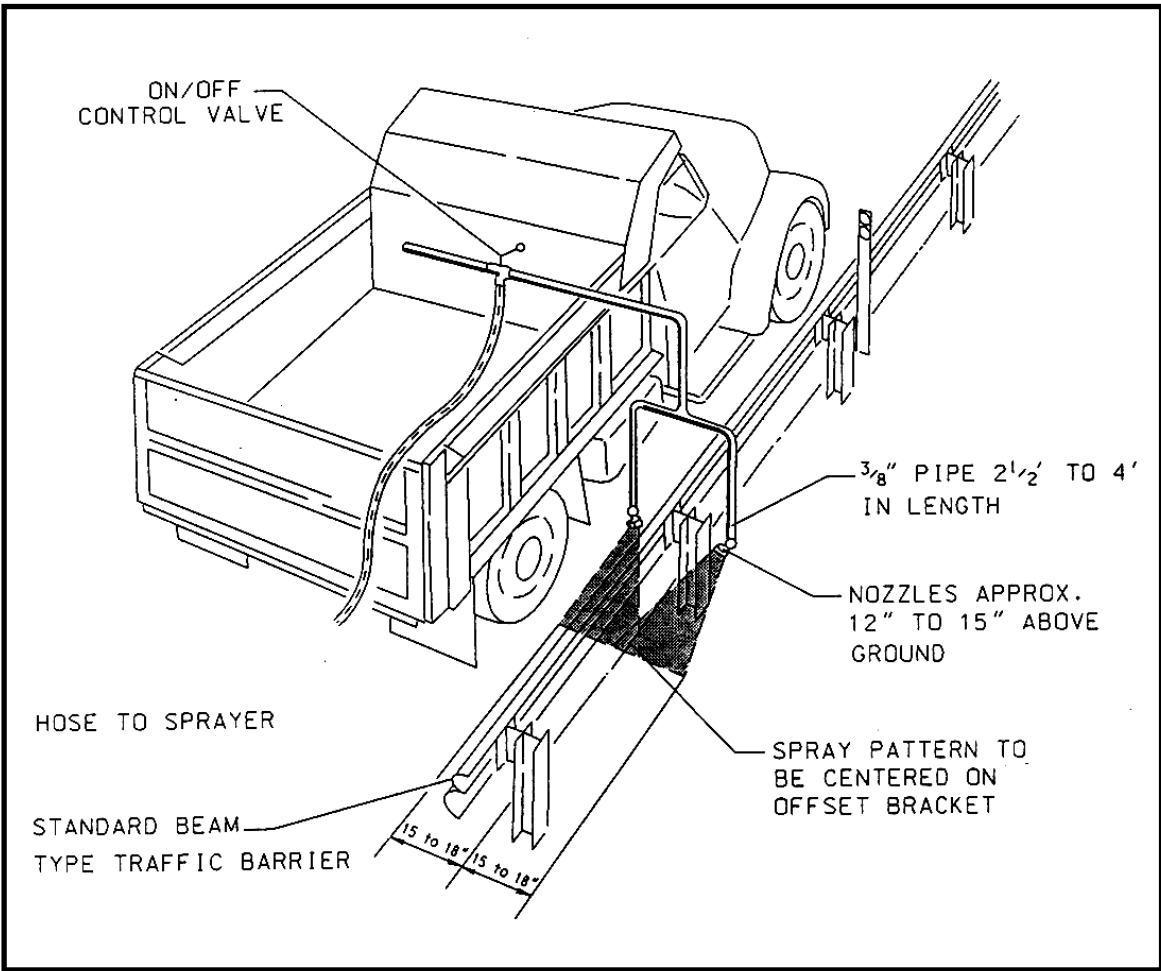

Table 21

**Reference Table to Determine Miles per Hour For
Control of Vegetation In Line of Traffic Barriers**

Gallons per Minute	MPH	Feet per 30 Seconds
0.85	2.0	88
1.05	2.5	110
1.1	2.6	114
1.13	2.7	119
1.18	2.8	123
1.22	2.9	128
1.25	3.0	132
1.3	3.1	136
1.35	3.2	141
1.38	3.3	145
1.43	3.4	150
1.47	3.5	154
1.52	3.6	158
1.55	3.7	163
1.6	3.8	167
1.63	3.9	172
1.68	4.0	176
1.73	4.1	180
1.77	4.2	185
1.82	4.3	189
1.85	4.4	194
1.9	4.5	198
1.93	4.6	202
1.98	4.7	207
2.02	4.8	211
2.07	4.9	216
2.1	5.0	220
2.14	5.1	224

Note: Figures in this table are based on a three (3) foot swath at 100 gallons per acre.

Spraying Equipment

EQUIPMENT FOR BRUSH CONTROL

This application requires low volumes and low pressure. The recommended equipment is the 400 gallons, 100 GPM (minimum) centrifugal pump sprayer. A sprayer mounted on an all terrain vehicle (ATV) may also be used to apply to small areas. “Backpack” sprayers are practical where the area to be treated is small and for spot treatment where vehicular accessibility is limited.

EQUIPMENT FOR POISON IVY, PHRAGMITES AND JOHNSONGRASS CONTROL

This application requires medium volumes and low pressure and is usually accomplished by walking around the poison ivy area to be treated, and through or around the Johnsongrass and Phragmites areas to be treated. The same sprayers can be used as mentioned above in brush control.

EQUIPMENT FOR WIRESTEM MUHLY CONTROL

This application requires low volume and gravity flow to a rope wick boom. This is accomplished by saturated ropes slowly rubbing Wirestem Muhly (or other weeds) where their height is eight (8) inches or more above the desired turf.

Herbicide Disposal

HERBICIDE AND HERBICIDE CONTAINER DISPOSAL

One of the most important phases of any herbicide spraying program is the safe and proper disposal of herbicide concentrates, herbicide solutions and herbicide containers. At all times, the disposal of these items must be conducted in a manner to prevent the contamination of the environment, air, water and soil. The US Environmental Protection Agency (EPA) is now stressing a container management policy which will encourage the return, re-use, refilling and recycling of pesticide containers. Maryland Department of Agriculture (MDA) has a program that provides pesticide users an opportunity to recycle empty pesticide containers. This program is a cooperative effort between MDA and several regional and county organizations and agencies. The University of Maryland Cooperative Extension Service also takes part.

Nine centrally located collection sites have been established in Maryland and are listed on page 74. Triple rinsed 2.5 gallon and smaller plastic pesticide containers can be offered for recycling on certain scheduled days. Any container that is not clean will be unacceptable and must be disposed of legally by the submitter. Further information can be provided by the Landscape Operations Division (LOD).

When herbicide concentrates become old and/or unusable, they may require disposal. Managing stock levels of herbicides can keep disposal issues to a minimum. Disposal of these materials create the most difficult and serious problems, due to their great ability to contaminate the surrounding environment. For this reason, LOD must be notified before disposal attempts are conducted for any herbicide concentrations.

When prepared herbicide solutions require disposal, the problem is not as difficult as with herbicide concentrates. First, the quantity of material is small, and the amount of prepared solution can be utilized within a short period of time in an appropriate area or can be stored until it is needed. Second, effort should be made to prepare only that amount of solution required for a specific job, so all the material is utilized.

All herbicide containers must be emptied completely before they are disposed. Liquid holding containers must be thoroughly rinsed 3 times with water before they are disposed at approved sites. The solution containing the rinse materials is not to be thrown away but is to be poured into the herbicide spray tank during mixing of the solution. This procedure will reduce possible contamination of the environment.

The following will serve as an aid in the disposal of herbicide concentrates, herbicide solutions and herbicide containers:

<u>Materials</u>	<u>Disposal Method(s)</u>
Herbicide concentrate(s)	Consult LOD
Herbicide solutions	Store until next day's operations, or spray in an appropriate area according to the recommended spray program.
Herbicide containers	Empty containers completely. Rinse liquid containers three (3) times as recommended above. Puncture containers, except glass, and submit to an approved disposal area. A MDA recycling facility (see list below) should be used.

Herbicide Disposal

MDA Pesticide Containers Recycling Collection Facilities	
Operation Hours 9:00 am – 3:00 pm (Contact Facilities for Collection Dates)	
County (City, Town)	Facility
Kent (Chestertown)	Nicholson Transfer Facility Earl Nicholson Road
Talbot (Easton)	MidShore Regional Solid Waste Facility Barker's Landing Road
Wicomico (Salisbury)	Wicomico County Landfill Brick Kiln Road
Anne Arundel (Lothian)	Southern States 6272 Southern Maryland Blvd.
Harford (Street)	Scarboro Landfill 3241 Scarboro Road
Prince George's (Beltsville)	USDA Research Center Bldg. 302 Visitor Center on Powder Mill Road
St. Mary's (California)	St. Andrew's Landfill Rte. 4 St Andrew's Church Road
Frederick (Frederick)	Frederick County Landfill 9031 Reich's Ford Road
Garrett (Mt. Lake Park)	Southern States Oakland Coop. 1862 Maryland Highway
Washington (Hagerstown)	Martin's Elevator 13219 Maugansville Road

RECORDS

It is extremely important that accurate records of each day's work be kept by the supervisor in charge of the spraying program. Information taken from these records is used in reviewing present programs and in planning programs for future years.

The information found on the Team Activity Card (used for herbicide application) is very valuable in the case of damage claims. It is the only source of information available to complete a yearly record of work accomplished, application costs and comparison of effectiveness of methods and materials.

Maryland Pesticide Regulations requires that all records must be retained on file for a period of two (2) years following application of all herbicides. Forward a copy to the Landscape Operations Division at the end of each weeks spraying.

A sample copy of the Team Activity Card is shown on the following page.

Herbicide Records



Maryland Department of Transportation
State Highway Administration
Highway Maintenance Division
HERBICIDE TEAM ACTIVITY CARD

Index #		Shop	
PCA #		Date	
AC1 #		Team Leader	

Work Order #s							
Comments:							

Agency Code 1	Description of Use
3301	Control of Thistles
3302	Control of Johnsongrass
3303	Control of Phragmites

Route				Milepoint		Accomplishments		Application Time			
Number	Direction/ Ramp	Lane/ Offset		Begin (From)	End (To)	WZTC #	Hours On Site	Acres	Gallons	Start	Finish
1											
2											
3											
4											
5											
6											
7											
8											

Labor

Team Member	Code	CD	RT	OT
Total Staff Hours (RT + OT)				

Equipment/Tools

Tag #	Description	Hours Used	Hours On-Site	Ending Odometer

Materials

Wind			Roadside			Median		
Direct	Speed		Swath	Miles	Acres	Swath	Miles	Acres
1								
2								
3								
4								
Totals								

			Quantity	
Code	Description	EPA Reg. #	Charged Out	Used

Weather			
Temp		Sunny	
Humidity		Overcast	
		Rain	

Application Equipment	
Guardrail Boom	
Shoulder Boom	
OC Nozzle	
Handgun	
Solid Stream Nozzle	

Vegetation to be Managed

Total Accomplishments			
Acres		Gallons	
Signature			

Herbicide Usage

DETERMINATION OF HERBICIDE USAGE AND ACCOMPLISHMENTS

(See Tables 22, 23, and 24)

These tables are designed to assist those reporting Daily Herbicide Usage on the Team Activity Cards. The tables have been developed to determine accurate quantities of chemical used.

First select the correct table and then determine the gallons of solution used, and the chemical rate per acre. The exact amount of herbicide used will appear in the block where the row and column meet.

Table 22

Herbicide Usage Based on 100 Gallons Per Acre Liquid

Gal. of Sol.	Chemical Rate per Acre Liquid									
	1 pt	1½ pt	1 qt	⅓ gal	½ gal	⅔ gal	¾ gal	1 gal	1¼ gal	2 gal
100	1.00 pt	1½ pt	1.00 qt	⅓ gal	½ gal	⅔ gal	¾ gal	1.00 gal	1¼ gal	2.00 gal
90	0.90 pt	1.43 pt	0.90 qt	1.17 qt	1.80 qt	2.40 qt	2.70 qt	3.60 qt	4.50 qt	7.20 qt
80	0.80 pt	1.28 pt	0.80 qt	1.04 qt	1.60 qt	2.26 qt	2.40 qt	3.20 qt	4.00 qt	6.40 qt
75	0.75 pt	1.20 pt	0.75 qt	0.98 qt	1.50 qt	2.13 qt	2.25 qt	3.00 qt	3.75 qt	6.00 qt
70	0.70 pt	1.05 pt	0.70 qt	1.82 pt	1.40 qt	1.86 qt	2.10 qt	2.80 qt	3.50 qt	5.60 qt
60	0.60 pt	0.90 pt	0.60 qt	1.56 pt	1.20 qt	1.61 qt	1.80 qt	2.40 qt	3.00 qt	4.80 qt
50	0.50 pt	0.75 pt	1.00 pt	1.30 pt	1.00 qt	1.34 qt	1.50 qt	2.00 qt	2.50 qt	4.00 qt
40	0.40 pt	0.60 pt	0.80 pt	1.04 pt	1.60 pt	1.08 qt	1.20 qt	1.60 qt	2.00 qt	3.20 qt
30	0.30 pt	0.45 pt	0.60 pt	0.78 pt	1.20 pt	1.62 pt	1.80 pt	1.20 qt	1.50 qt	2.40 qt
25	0.25 pt	0.38 pt	0.50 pt	0.65 pt	1.00 pt	1.33 pt	1.50 pt	1.00 qt	1.25 qt	2.00 qt
20	0.20 pt	0.30 pt	0.40 pt	0.52 pt	0.80 pt	1.06 pt	1.20 pt	1.60 pt	1.00 qt	1.60 qt
15	0.15 pt	0.23 pt	0.30 pt	0.39 pt	0.60 pt	0.80 pt	0.90 pt	1.20 pt	1.50 pt	1.20 qt
10	0.10 pt	0.15 pt	0.20 pt	0.26 pt	0.40 pt	0.53 pt	0.60 pt	0.80 pt	1.00 pt	1.60 pt
9	0.09 pt	0.12 pt	0.18 pt	0.24 pt	0.36 pt	0.48 pt	0.54 pt	0.72 pt	0.90 pt	1.44 pt
8	0.08 pt	0.10 pt	0.16 pt	0.21 pt	0.32 pt	0.43 pt	0.48 pt	0.64 pt	0.80 pt	1.28 pt
7	0.07 pt	0.10 pt	0.14 pt	0.19 pt	0.28 pt	0.37 pt	0.42 pt	0.56 pt	0.70 pt	1.12 pt
6	0.06 pt	0.08 pt	0.12 pt	0.16 pt	0.24 pt	0.32 pt	0.36 pt	0.48 pt	0.60 pt	0.96 pt
5	0.05 pt	0.07 pt	0.10 pt	0.13 pt	0.20 pt	0.27 pt	0.30 pt	0.40 pt	0.50 pt	0.80 pt
4	0.04 pt	0.05 pt	0.08 pt	0.11 pt	0.16 pt	0.21 pt	0.24 pt	0.32 pt	0.40 pt	0.64 pt
3	0.03 pt	0.05 pt	0.06 pt	0.08 pt	0.12 pt	0.16 pt	0.18 pt	0.24 pt	0.30 pt	0.48 pt
2	0.02 pt	0.03 pt	0.04 pt	0.05 pt	0.08 pt	0.11 pt	0.12 pt	0.20 pt	0.20 pt	0.32 pt
1	0.01 pt	0.02 pt	0.02 pt	0.03 pt	0.04 pt	0.05 pt	0.06 pt	0.08 pt	0.10 pt	0.16 pt

Herbicide Usage

Table 23

**Herbicide Usage Based on 100 Gallons of Solution Per Acre
for Dry Material**

Gal of solution	Chemical Rate per Acre Dry Material		
	5 lbs	6 lbs	10 lbs
100	5.00 lb	6.00 lb	10.00 lb
90	4.50 lb	5.40 lb	9.00 lb
80	4.00 lb	4.80 lb	8.00 lb
75	3.75 lb	4.50 lb	7.50 lb
70	3.50 lb	4.20 lb	7.00 lb
60	3.00 lb	3.60 lb	6.00 lb
50	2.50 lb	3.00 lb	5.00 lb
40	2.00 lb	2.40 lb	4.00 lb
30	1.50 lb	1.80 lb	3.00 lb
25	1.25 lb	1.50 lb	2.50 lb
20	1.00 lb	1.20 lb	2.00 lb
15	0.75 lb	0.90 lb	1.50 lb
10	0.50 lb	0.60 lb	1.00 lb
9	0.45 lb	0.54 lb	0.90 lb
8	0.40 lb	0.48 lb	0.80 lb
7	0.35 lb	0.42 lb	0.70 lb
6	0.30 lb	0.36 lb	0.60 lb
5	0.25 lb	0.30 lb	0.50 lb
4	0.20 lb	0.24 lb	0.40 lb
3	0.15 lb	0.18 lb	0.30 lb
2	0.10 lb	0.12 lb	0.20 lb
1	0.05 lb	0.06 lb	0.10 lb

Herbicide Usage

Table 24

Herbicide Usage Based on 50 Gallons Per Acre (Liquid and Dry)

Gal of Sol.	Chemical Rate per Acre Liquid							Dry
	1.00 oz	$\frac{3}{4}$ pt	$\frac{1}{3}$ gal	$\frac{1}{2}$ gal	$\frac{3}{4}$ gal	1 gal	1 $\frac{1}{4}$ gal	0.25 oz
50	1.00 oz	$\frac{3}{4}$ pt	$\frac{1}{3}$ gal	$\frac{1}{2}$ gal	$\frac{3}{4}$ gal	1 gal	1 $\frac{1}{4}$ gal	0.25 oz
40	0.80 oz	0.60 pt	1.08 qt	1.60 qt	2.40 qt	3.20 qt	4.00 qt	0.20 oz
30	0.60 oz	0.45 pt	1.62 pt	1.20 qt	1.80 qt	2.40 qt	3.00 qt	0.15 oz
25	0.50 oz	0.38 pt	1.33 pt	1.00 qt	1.50 qt	2.00 qt	2.50 qt	0.13 oz
20	0.40 oz	0.30 pt	1.06 pt	1.60 pt	1.20 qt	1.60 qt	2.00 qt	0.10 oz
10	0.20 oz	0.15 pt	0.53 pt	0.80 pt	1.20 pt	1.60 pt	1.00 qt	0.05 oz
9	0.18 oz	0.14 pt	0.48 pt	0.72 pt	1.08 pt	1.44 pt	3.60 pt	0.04 oz
8	0.16 oz	0.12 pt	0.43 pt	0.64 pt	0.96 pt	1.28 pt	3.20 pt	0.04 oz
7	0.14 oz	0.11 pt	0.37 pt	0.56 pt	0.84 pt	1.12 pt	2.80 pt	0.03 oz
6	0.12 oz	0.09 pt	0.32 pt	0.48 pt	0.72 pt	0.96 pt	2.40 pt	0.03 oz
5	0.10 oz	0.08 pt	0.27 pt	0.40 pt	0.60 pt	0.80 pt	2.00 pt	0.02 oz
4	0.08 oz	0.06 pt	0.21 pt	0.32 pt	0.48 pt	0.64 pt	1.60 pt	0.02 oz
3	0.06 oz	0.05 pt	0.16 pt	0.24 pt	0.36 pt	0.48 pt	1.20 pt	0.01 oz
2	0.04 oz	0.03 pt	0.11 pt	0.20 pt	0.24 pt	0.32 pt	0.80 pt	0.01 oz
1	0.02 oz	0.02 pt	0.05 pt	0.08 pt	0.12 pt	0.16 pt	0.40 pt	0.01 oz

COMPUTATIONS

Several formulas must be known in order to apply accurate rates of spray material. One formula is required to determine the size of nozzle in GPM that is required to deliver a specific volume of spray solution per acre.

$$\text{GPM} = \frac{\text{MPH} \times \text{SS} \times \text{GPA}}{495}$$

GPM = Gallons per minute, to determine size of nozzle required.

MPH = Miles per hour to be traveling while spraying.

SS = Spray swath in feet.

GPA = Gallons of spray solution per acre.

EXAMPLE:

Assuming a traffic barrier is to be sprayed at a rate of 100 gallons of spray solution per acre on a strip 2.5 feet wide and traveling at 3 MPH. Using the figures known, the formula appears to be as follows:

$$\text{GPM} = \frac{3.0 \times 2.5 \times 100}{495}$$

$$\text{GPM} = 1.5$$

In this illustration the nozzles required would have to deliver 1.5 gallons per minute of spray solution, or .75 gallons per minute for each of the two (2) nozzles.

Other formulas often used in making calculations for spray applications include the following:

To determine gallons per acre:

$$\text{GPA} = \frac{495 \times \text{GPM}}{\text{MPH} \times \text{SS}}$$

To determine miles per hour:

$$\text{MHP} = \frac{495 \times \text{GPH}}{\text{GPA} \times \text{SS}}$$

Appendix II

CALIBRATION SHEET FOR ROADSIDE SPRAYERS

Date: _____

County: _____ Truck License No. _____ Sprayer License No. _____

VEGETATION TO BE MANAGED: _____

Application Equipment (circle one): Guardrail Boom/Shoulder Boom/OC Nozzles/ Handgun

Chemical	Lbs. A.I. (liquid)	= Gallons	Lbs. (WP/DF)
_____	_____	_____	_____
_____	_____	_____	_____
_____	_____	_____	_____
_____	_____	_____	_____

Gallons of Spray Solution Required Per Acre: _____ *GPA*.
 (Above chemicals to be mixed in this volume)

When using a handgun, place above chemicals in _____ gallons of water.

If nozzle pressure is unknown, select *SS*, *MPH* and *GPM* to deliver the above selected *GPA* and adjust pressure to produce the desired *GPM*.

Pressure (<i>PSI</i>)	Nozzle Size	Gallons per Minute (<i>GPM</i>)
_____	_____	_____
_____	_____	_____
_____	_____	_____
_____	_____	_____
_____	_____	_____
TOTAL <i>GPM</i>		_____

If *MPH* is unknown, select *SS*, determine *GPM* and nozzle pressure to same *SS* and determine *MPH* as follows:

$$\frac{495 \times GPM (\quad)}{GPA (\quad) \times SS (\quad)} = \text{_____ } MPH$$

Note: 44 X *MPH* () = _____ feet per 30 seconds.

Spray Truck Listed Above runs:

_____ (*MPH*), in _____ *Gear*, _____ *Range*, at _____ *RPM*.

Calibration by: _____

Appendix III

U.S. AND METRIC WEIGHTS AND MEASURES

WEIGHT

<u>Avoirdupois</u>	<u>Metric</u>	<u>Metric</u>	<u>Avoirdupois</u>
1 ounce (oz)	28.35 grams (g)	1 gram	0.03527 ounces
1 pound (lb)	453.59 grams	1 kilogram (1,000 gms)	2.205 pounds

LIQUID MEASURE

<u>U.S. Units</u>	<u>Metric</u>	<u>Metric</u>	<u>U.S. Units</u>
1 fluid ounce	29.57 milliliters (ml)	1 milliliter	0.038 fluid oz(fl oz)
1 pint (pt)	0.47 liter	1 liter	2.113 pints
1 quart (qt)	0.95 liter	1 liter	1.057 quarts
1 gallon (gal)	3.78 liters	1 liter	0.2642 gallons

LINEAR MEASURE

<u>U.S. Units</u>	<u>Metric</u>	<u>Metric</u>	<u>U.S. Units</u>
1 inch	2.54 centimeters (cm)	1 centimeter	0.3937 inches
1 inch	25.4 millimeters (mm)	1 meter	39.37 inches
1 foot	30.48 centimeters	1 meter	3.281 feet
1 yard	0.91 meter (m)	1 kilometer	3281 feet
1 mile	1.61 kilometer (km)	1 kilometer	0.6214 mile

AREA MEASURE

<u>U.S. Units</u>	<u>Metric</u>	<u>Metric</u>	<u>U.S. Units</u>
1 square inch (in ²)	6.45 square centimeters (cm ²)	1 square centimeter	0.155 square inches
1 square foot (ft ²)	929 square centimeters	1 square meter (m ²)	10.76 square feet
1 square yard (yd ²)	0.836 square meter	1 square meter	1.196 square yards
1 acre	4047 square meters	1 hectare	2.471 acres
1 square mile (mi ²)	2.59 square kilometers (km ²)	1 square kilometer	0.3861 square miles

Appendix IV

CONVERSION TABLE OF U.S. AND METRIC WEIGHTS AND MEASURES

<u>Multiply</u>	<u>To Obtain</u>
Centimeters by 0.3937	Inches
Cu. Centimeters by 0.6102	Cu. Inches
Cu. Feet by 1728	Cu. Inches
Cu. Feet by 0.02832	Cu. Meters
Cu. Feet by 7.48052	Gallons
Cu. Feet by 28.32	Liters
Cu. Inches by 16.39	Cu. Centimeters
Cu. Inches by 0.004329	Gallons
Cu. Inches by 0.01639	Liters
Cu. Meters by 264.2	Gallons
Feet by 30.48	Centimeters
Feet by 0.3048	Meters
Gallons by 3785	Cu. Centimeters
Gallons by 3.785	Liters
Inches by 2.54	Centimeters
Kilometers by 0.6214	Miles
Liters by 1.057	Quarts
Liters by 0.242	Gallons
Ounces by 28.3	Grams or Milliliters
Pounds by 454	Kilograms
Tablespoons by 0.5	Ounces
Tablespoons by 1.48	Milliliters
Meters by 39.37	Inches
Meters by 3.281	Feet
Meters by 1.094	Yards
Meters by 1.609	Kilometers
Miles per Hr. x 1.609	Kilometers per Hr.
1 lb/Acre = 1.12 Kg/Hectare	
1 gal/Acre = 9.34 L/Hectare	

MARYLAND POISON CONTROL CENTERS

Certain hospitals or clinics in Maryland have been designated as Poison Control or Information Centers. In the case of a pesticide emergency, call your physician or nearest Poison Control Center **at once** for advice and directions (see list below) or go to a local hospital emergency room. Be prepared to give the name of the pesticide (active ingredient) to the doctor or Poison Control Center. The accident victim should be taken to the doctor or Poison Control Center by someone not exposed to the chemical.

**Maryland Poison Information Center
Baltimore, Maryland
Poison Emergency – Call (410) 528-7701**

If outside the Baltimore local dialing area (a long distance call), call Toll Free 1(800) 492-2414 or 1(800) 222-1222.

POISON CONTROL CENTERS	
ADDRESS	TELEPHONE
Baltimore University of Maryland 20 N. Pine Street Baltimore, Maryland 21201-1180	Telephone 1 (410) 706-7701 TDD (410) 706-1858
Washington George Washington Medical Center 3201 New Mexico Ave., Northwest, Suite 310 Washington, D.C. 20016	Telephone 1 (202) 625-3333

Appendix VI

HERBICIDE SUSCEPTIBILITY OF WEEDS

WEED SPECIES	2,4-D	Garlon 3A	Vanquish
Annual Sow Thistle	S	S	S
Bindweed Field	I	S	S
Burdock	S	R	S
Buttercup	S-I	R	S
Carrot, Wild	S-I	S-I	S
Chicory	S	S	S
Clovers	S-I	S-I	S-I
Dandelion	S	S	S
Dock	S-I	S-I	S-I
Dodder	R	R	R
Garlic, Wild	I	R	S-I
Goldenrod	I	I	--
Grasses	R	R	R
Henbit	R	R	S
Honeysuckle	S-I	---	S
Horsenettle	I-R	---	S
Knapweeds			
Kudzu	R	R	S
Lambsquarter	S	S	S
Lettuce, Wild	S	S	S
Milkweed	R	S-I	S
Mullein	R	R	R
Mustards	S	S	S
Pigweeds	S	---	S
Plantains	S	S	S
Poison Ivy, Oak	I	S	S
Ragweed	S	S	S
Rose, Multiflora	R	R	S
Sheep Sorrell	R	S	S
Thistle, Bull	S	S	S
Thistle, Canada	I	S	S
Yarrow	I-R	S	I

S = Susceptible to Herbicides; **I** = Intermediate; **R** = Resistant (Not Susceptible)

Species rated "Intermediate" may be controlled with more than one application.

PAGE LEFT BLANK

Mowing Standards

INTRODUCTION

Mowing is a vital maintenance activity that requires thoughtful planning, scheduling and supervision to achieve a functional, safe and attractive highway system. Mowing is performed to maintain sight distance for the motoring public, maintain turf quality, control undesirable brush and noxious weeds, manage wildflower meadows, and provide an aesthetically pleasing appearance. Highway corridors, which travel through residential and commercial areas, will require more mowing than rural, non-residential and non-commercial areas.



GOALS

The goals of the Administration's mowing program are to ensure safety to the motorist, properly maintain our drainage systems and provide a neat appearance. Other goals include the enhancement of quality turf, establishment of meadow and the compliance of state laws in the control of noxious weeds. These goals can be obtained through the cooperative effort and commitment of each individual involved in the mowing program. Mowing requires a careful and thoughtful determination as to whether an area should be mowed or not mowed. If an area is to be mowed, the mow limit, the equipment to be used, the frequency and priority of mowing needs to be known and followed by our front-line managers. For assistance in answering any concerns relating to these guidelines, contact the Landscape Operations Division (LOD) and/or the Highway Maintenance Division (HMD).

These guidelines are to help achieve appropriate and uniform mowing statewide and to ensure the goals of the mowing program are achieved.

PURPOSE FOR MOWING

Improve Safety

The mowing program is designed to promote safety for the traveling public. Mowing limits are established to maintain adequate sight distances, safe recovery areas and full view of traffic barriers. Proper sight distance for highway safety must be given priority in making decisions regarding areas to mow first, frequency of mowing or to leave an area unmowed.

Promote Drainage

Proper drainage is important by preventing standing water on roadways, flooding and damage to highway structures. Mowing should be performed to control vegetation so it stabilizes soil and allows for the free flow of water. Failure of water to flow away from the shoulder can result in water seeping under the roadway and eventually causing roadway failure.

Mowing Standards

Increase Aesthetics

Mowing provides a neat appearance to turf areas by cutting of grass to a uniform height and by defining a well-kept edge to less managed areas.

Achieve Turf Quality

The highest level of turf quality is achieved through proper mowing, the application soil amendments and the control of weeds. Proper mowing will enhance turf quality, improve appearance, aid in controlling erosion and extend the intervals between mowing.

Control Noxious and Nuisance Weeds

State law requires that each landowner manage land infested with Johnsongrass or thistles (Bull, Canada, Musk, Nodding and Plumeless) to prevent seed set of Johnsongrass or flowering of thistles. Phragmites must also be controlled. Mowing is one method to prevent these weeds from producing seed.



Manage Wildflowers and Meadows

Many desirable and naturally occurring wildflowers are growing along our highways, such as Black-eyed Susan, Butterfly Weed, Golden Rod, and New England Aster. In some areas, wildflowers are seeded to provide additional stands of flowers. In other areas wildflowers and meadows occur naturally if left unmowed. Wildflowers and meadows require different vegetation management practices than turf to survive and produce the most visible flowering effect. Meadows provide a stand of native and naturally occurring grasses, legumes, sedges and wildflowers beyond the normal mow area. Like wildflowers, meadows can benefit from selected mowing when needed.

Promote Desirable Natural Vegetation

The regeneration of natural vegetation provides a stand of native ground covers, woody shrubs and trees beyond the mow area to the edge of the right-of-way. These areas should not be mowed except to control undesirable vegetation as directed by the Landscape Operations Division (LOD). Desirable natural vegetation includes selected ground covers, wildflowers, trees and shrubs.



Mowing Practices

MOWING PRACTICES

The following practices will aid in maintaining turf quality and managing desirable and undesirable vegetation:

Turf

- Maintain mowing blades in a sharpened condition to provide a clean cut to reduce injury to the grass blade and reduce browning.
- Perform mowing at the designated mowing heights to maintain healthy grass and avoid scalping and clumping of clippings that can smother turf.
- Set and operate equipment properly so to prevent gouging of the turf.
- Mow when soil conditions are able to support the equipment, to avoid rutting, and permit safe and efficient operation of equipment.
- Do not mow when turf is drought stressed or wilting. Mowing under these conditions can result in turf browning and turf failure.
- When possible, avoid removing more than 1/2 of grass leaf area to reduce plant shock and minimize root dieback.

Managing Desirable Vegetation

- When mowing in areas of landscape plantings and selected woody vegetation, avoid damaging trees and shrubs with tractor wheels, mowing decks, etc. Keep off berms constructed at the base of planted trees. Mow around groups of trees rather than between them. Herbicides may be used around trees to reduce hand and tractor mowing.
- Mow to encourage and maintain desirable vegetation within drainage areas and around inlets. Concrete, riprap, and vegetated ditches shall be kept free of trees and brush through spot mowing or treating with herbicides.

Managing Undesirable Vegetation

- Timely mowing is also effective in the control of noxious weeds. Perform spot mowing at the site of the noxious weeds. Prevent seed set of Johnsongrass and the flowering of thistles by either mowing, treating with herbicides and/or the use of biological control.
- Phragmites, a nuisance weed, shall also be controlled through spraying or mowing.
- Perform spot mowing or spraying as needed to control brush to maintain site lines.

Mowing Priorities and Heights

MOWING PRIORITIES

Priority 1

- Offices, shops, information and exhibit centers, rest and picnic areas, weigh and inspection stations.
- Curbed medians and islands.
- Medians, roadsides, and interchange triangles in residential and commercial areas.
- Park and Ride Facilities.
- Safety sensitive areas to maintain sight distances for traffic signs and signals, at sharp curves, interchanges, entrances, intersections and other sensitive areas.

Priority 2

- Medians, roadsides and interchanges in non- residential and non-commercial areas.
- Areas in front of traffic barriers, shrub beds and wildflowers.

Priority 3

- Areas behind traffic barriers.
- Areas on cut slopes above ditches.

MOWING HEIGHTS

The minimum mowing heights shall be determined by measuring from the ground level to the extended grass cut edge. Set mower decks and skids so they do not gouge and damage the turf. The blades shall cut at the following minimum heights:

- 2½ - 3"** for hand and tractor mowers for offices, shops, information and exhibit centers, rest and picnic areas, weigh and inspection stations, curbed medians and islands, and park and rides.
- 3½ - 4½"** for tractor mowers for uncurbed medians and roadsides.
- 5 - 7"** for tractor mowers for wildflower areas, meadows and areas mowed only once or twice a year.

Mowing General Areas

MOWING GENERAL AREAS

Offices, Shops, Information and Exhibit Centers, Rest and Picnic Areas, Weigh and Inspection Stations, and Park and Rides.

Mow entire area unless otherwise designated as a “No Mow Area”.

Maintain grass height between 2½” minimum and 5” maximum.

Residential and Commercial areas flatter than 3:1

Effort should be made to mow these areas before the grass reaches a height of 15”.

Roadsides and Intersection Triangles.

- Mow entire area unless designated as a “No Mow Area.”

Interchange Loops.

- Mow up to 20 - 24’ from the curb or 12 - 16’ from the outside edge of the shoulder.

Medians less than 72’ wide.

- Mow entire area unless designated as a “No Mow Area”.



Medians (72’ or wider).

- Mow 20 - 24’ from the outside edge of the shoulder.
- From late May to mid-June, mow an additional 12-16’ at a mowing height of 5-7”.

Non-Residential and Non-Commercial areas flatter than 3:1

Effort should be made to mow these areas before the grass reaches a height of 30”. Reforested areas shall not be mowed.

Roadsides and Interchanges.

- Mow 12 - 16’ from the outside edge of the shoulder. These distances may be extended at interchanges to maintain sight distances. Manage the additional areas as wildflower areas or meadows.

Mowing General Areas

- Roadsides adjacent to cultivated fields.
 - Mow a maximum of 6 - 7' from the right-of-way line.
- Medians (less than 40' wide).
 - Mow the entire area.
- Medians (40' to less than 72' wide).
 - Mow 12 - 16' from the outside edge of the pavement. Manage the center as wildflower areas or meadows.
- Medians (72' and wider).
 - Mow same as above except allow for regeneration of desirable natural vegetation 30' beyond the shoulder edge.



Mowing Specific Areas

MOWING SPECIFIC AREAS

Sight Distance

Mow to maintain proper sight distance at acceleration/deceleration lanes, interchange ramps, traffic signs, crossovers and intersections.

Visibility of Wildflowers and Shrub Beds

Mow in front of wildflower areas and shrub beds on the side closest to the highway. If needed mow on the backside of wildflowers if it opens them to view of the public. Mow wildflower areas as directed by the Landscape Operations Division (LOD) at the end of the growing season.

Wide Areas

Where wide areas exist, variable mowing should be performed rather than continuous parallel mowing to the shoulders. Variable mowing will provide a more interesting and pleasing highway as it blends in with the natural land features (ditches, wood lines and recovery areas). Mow in sweeping curves rather than irregular and sharp turns.

Fill Slopes Behind Traffic Barriers

On fill slopes, mow 2 - 7' behind traffic barriers once or twice a year. Herbicides may reduce the need for hand trimming under traffic barriers.

Steep Cut Slopes Close to Roadways

On steep cut slopes (steeper than 3:1) and where the toe of the slope is less than 5' from the outside edge of the shoulder and sight distance is needed, mow 5 – 7' above the ditch. If the toe of the slope is 5 – 25' from the outside of edge of the shoulder, keep the area 5 – 7' above the ditch free from trees and brush through spot treating with herbicides or spot mowing at the end of the mowing season.

Visibility of Traffic Obstacles

Mow a swath to allow access to variable message signs, traffic advisory radios, lighting sensors, cabinets, transformers, hydrants and fire doors in noise barrier walls or as directed by the Office of Maintenance (OOM).

Late Fall Mowing

Late fall mowing will be required to maintain extra site distance, control invasive plants and provide an attractive appearance. Perform late fall mowing where required by following smooth contours and wood lines avoiding sharp and irregular mow lines. Vegetation should be mowed at a height of no less than 7".

Mowing Summary

MOWING CHART

PRIORITY	LOCATIONS	MOWING HEIGHT IN INCHES	SPECIAL INSTRUCTIONS
1	FACILITIES <input type="checkbox"/> Information Centers, Rest and Picnic Areas, Weigh Stations, Curbed Medians And Islands <input type="checkbox"/> Park & Rides	2 ½ - 3 3 ½ - 4 ½	Mow Entire Area Unless Designated “No Mow Area”
	RESIDENTIAL AND COMMERCIAL AREAS Roadsides, Interchange Triangles And Medians Less Than 72’ Wide	3 ½ - 4 ½	Mow All Areas 3:1 And Flatter Unless Designated “ No Mow Area”
	Interchange Loops	3 ½ - 4 ½	Mow 20-24’ From The Curb Or 12-16’ From The Outside Edge Of The Shoulder
	Medians 72’ Or Wider	3 ½ - 4 ½	Mow 20-24’ From The Outside Edge Of The Shoulder
2	NON-RESIDENTIAL AND NON-COMMERCIAL AREAS Roadsides And Interchange Triangles	3 ½ - 4 ½	Mow 12-16’ From The Outside Edge Of The Shoulder
	<input type="checkbox"/> Medians Less Than 40’ Wide <input type="checkbox"/> Medians 40 To 72’ Wide	3 ½ - 4 ½	<input type="checkbox"/> Mow The Entire Area <input type="checkbox"/> Mow 12-16’ From The Outside Edge Of Shoulder
	Traffic Barriers, Shrubs And Wildflowers	3 ½ - 4 ½	Mow To The Front Side
	Selected Meadows, Wild Flower Sites And Areas Adjacent To Cultivated Fields	5-7	Mow Once A Year In Late June And If Needed Once Again In The Fall
3	3:1 CUT SLOPES (When The Ditch Is Within 30’ Of White Edge Line)	3 ½ - 4 ½	Spot Mow Trees And Brush 5-7’ Above The Ditch Line From July Through October

ADDITIONAL INSTRUCTIONS

1. Starting mowing heights should be guided by sight requirements, safety, existing height, and budgetary considerations. Mow as necessary.
2. Entrances to the state and communities should be mowed full width for approximately ¼ to ½ mile, providing a smooth transition to the special instructions above.
3. Mow wildflower areas and meadows at the direction of the Landscape Operations Division.
4. Mow a swath to provide access to variable message signs, traffic advisory radios, cabinets, transformers, hydrants, fire doors or as directed by the Highway Maintenance Division.

Turfgrass Management Guidelines

INTRODUCTION. Turfgrass management is a vital maintenance activity that requires thoughtful planning, scheduling and supervision to achieve a safe, functional, sustainable and attractive highway system.

GOALS. The goals of the Administration's turfgrass management program are to ensure safety to the motorist, promote environmental stewardship, and to enhance the quality of desirable vegetation. These goals can be obtained through the cooperative effort and commitment of each individual involved in the turfgrass management program. Turfgrass management requires a careful and thoughtful determination as to whether an area should be mowed or not mowed. If an area is to be mowed, the mow limit, equipment to be used, and the frequency of turfgrass management needs to be known and followed by the front-line managers.



These guidelines help to achieve appropriate and uniform statewide turfgrass management and to ensure the goals of the Administration's are achieved. For assistance in answering any concerns relating to these guidelines, contact the Statewide Vegetation Management Team.

- **Safety.** Turfgrass management shall be consistently performed to maintain sightlines and safety to the travelling public. Mowing operators shall observe all safety precautions and avoid dispersing clippings and debris onto the roadway and shoulder surfaces, which could be hazardous to motorists and cyclists as well. Turfgrass management limits are established to maintain adequate sight distances, safe recovery areas and full view of traffic barriers for delineation. Proper sight distance for highway safety must be given priority in making decisions regarding areas to mow first, the frequency of mowing or to leave an area unmowed.
- **Environmental Stewardship.** Turfgrass management shall be performed to preserve vegetation and promote its functional attributes of soil stabilization, erosion control, nutrient uptake and the control of restricted noxious and other nuisance weeds.
- **Enhance the Quality of Desirable Vegetation.** The quality of vegetation is enhanced by proper turfgrass management techniques. The existing vegetation must be taken into consideration when determining the trimming, frequency and height of mowing in an area.

TERMS AND DEFINITIONS.

- **One-pass cycle** – A chemical or mechanical treatment that is confined to 10 ft from the pavement edge. The standard placement for guardrail with delineator is within 6 ft of the pavement edge. Mechanically mow the area between the pavement edge and guardrail with delineators. Perform chemical treatments or hand mowing to maintain vegetation at the guardrail.
- **Full width cycle** – A mechanical treatment of a reasonable portion of the right of way that manages wood vegetation to maintain adequate sight distances and safe recovery areas (refer to Part 4 – Woody Vegetation Management Standards for tree setback guidelines). Initiate a full width cycle in all areas in late September or October. The limits of the full width cycle should include all areas with guardrail. Do not mow areas 3:1 and steeper.



Guardrail with delineator

Turfgrass Management Guidelines

MOWING. The following practices will aid in maintaining turfgrass quality during mowing operations:

- Avoid mowing when the turf is drought stressed or wilting to avoid browning and failure of turfgrass. Do not perform mowing during hot and dry weather periods of July and August or on "Ozone Warning" days.
- Perform mowing when soil conditions are able to support the weight of the equipment, avoiding rutting and permitting the safe and efficient operation of the equipment.
- Maintain mowing blades in a sharpened condition to provide a clean cut to reduce injury to the grass blade and reduce browning.
- Perform mowing at the designated heights to maintain healthy turfgrass and avoid scalping and clumping of clippings that can smother turfgrass.

LOCATIONS	MOWING HEIGHT (inches)	FREQUENCY
Information and Exhibit Centers Rest and Picnic Areas Urban, commercial and streetscape areas of special priority as determined by District Engineer. SHA Offices and Maintenance Shops	3	Mow entire area when turfgrass reaches 8 in. in height
Restricted Visibility Areas Intersections and Crossovers Interchange Loops Acceleration and Deceleration Ramps Curbed Medians, Islands and Roundabouts Park and Rides Weigh and Inspection Stations	6	Mow entire area when turfgrass reaches 16 to 18 in. in height
Medians – less than 30 ft width; flatter than 3:1	6	Mow entire area; limit to 3 cycles per year
Medians – greater than 30 ft width; flatter than 3:1	6	Conduct one-pass cycle; limit to 3 cycles per year
Roadsides	6	Conduct one-pass cycle; limit to 3 cycles per year
Utilities Communication Assets Signal Cabinets Transformers Fire Doors & Hydrants	6	Conduct a one-pass cycle to maintain access; limit to 3 cycles per year
Traffic Barriers within 10 ft of pavement edge	6	Conduct one-pass cycle when turfgrass reaches 18 in. in height
Traffic Barriers greater than 10 ft from pavement edge	6	Mow during full-width cycle at the end of the mowing season
Cut Slopes – Ditch within 30 ft of travel lane	6	Conduct one-pass cycle at end of mowing season
Specialty Areas Areas Surrounding Landscape Beds Native Meadows	Contact the Landscape Operations Division	
Scenic Byways	Contact the Landscape Architecture Division - Scenic Byways Coordinator	

Woody Vegetation Management Standards

INTRODUCTION

The Woody Vegetation Management Standards define specific practices for encouraging and sustaining desirable vegetation on highway slopes and flat areas. Such treatments improve the aesthetic quality of roadside areas; provides added safety through retention of sight lines and sign visibility; and encourages system preservation due to improved drainage.



The Standards also involve specific maintenance practices to provide safety to the motorist, to encourage good stewardship of desirable woody vegetation and to provide for a sustainable right of way with aesthetics in mind. Woody vegetation includes trees, shrubs, ground covers and vines. The Standards outline practices to improve the quality of roadsides that result in added safety to the public. The standards and work performed shall conform with ANSI (American National Standards Institute) A300 and ANSI Z133.

GOALS

Goals include maintaining safety, sustainability, aesthetics, stewardship and compliance with the Maryland Roadside Tree Law.

Safety – Recovery areas, site distance, safe travel, and hazardous trees.

The Woody Vegetation Management Standards provides procedures for maintaining proper sight distance for signs, metal traffic barriers and other structures. Sight distance is to be maintained at entrances and intersections and other areas to maintain a safe and continuous traffic flow. On roadsides and in certain medians, proper recovery areas need to be maintained. Safe travel shall be provided by maintaining natural lighting to the highway to increase winter melting of snow and ice, and by reducing limb and leaf fall. Where hazardous trees exist, they need to be identified and mitigated for removal or possible pruning and/or repair. Some trees that are removed may need replacing in accordance with the Maryland Roadside Tree Law.

Sustainability – Low maintenance, stability, and drainage.

Woody vegetation shall be managed so there is long term low maintenance. Desirable vegetation shall be selected and managed to stabilize slopes and other areas. Positive drainage shall be provided and maintained through removing trees and other selected woody vegetation that would obstruct the flow of water in ditches.

Purpose

Aesthetics – Areas of reforestation, meadows, seasonal interests, tree groupings, and balance.

Woody vegetation management shall be performed to promote and protect reforestation and meadows. Seasonal interests can be developed through the encouragement of selective woody vegetation. Encourage desirable tree and shrub groupings to provide for a natural balance of species.

Stewardship – Native, naturalized and planted vegetation and implement Integrated Pest Management (IPM) program.

The stewardship of managing woody vegetation involves preserving beneficial, native, naturalized and planted material. Good stewardship involves the use of an Integrated Pest Management (IPM) program and the protection of Maryland forests and natural resources. IPM is a process that uses the most appropriate pest control methods, be it mechanical, cultural, biological or chemical, to economically meet pest management objectives.

Maryland Roadside Tree Law – The Department of Natural Resources (DNR), compliance, permitting, Tree Care Expert Certificate, and consultation with the Landscape Operations Division (LOD).

SHA shall partner and maintain good communication with DNR in order to effectively coordinate activities covered under the Woody Vegetation Management Standards. Each shop shall be encouraged to have personnel certified as a “Tree Care Expert” so work can be performed under their supervision. Work shall be performed as per the Maryland Roadside Tree Law and any necessary permits shall be acquired through the local forester. LOD shall be consulted when work is being scheduled and performed so there can be a coordination of planting and design activities between the two offices involving tree pruning, removal and chemical application.

PURPOSE

The following bullets summarize the many reasons that woody vegetation management is needed to provide safe, aesthetically pleasing, and sustainable roadsides. Work performed must be in compliance with the Maryland Tree Law and exhibit responsible stewardship of the environment.

Safety

- Retain sight lines for safe movement of traffic.
- Maintain safe recovery areas to reduce damage to vehicles and occupants.
- Provide setbacks based upon route characteristics and travel speed.
- Maintain sight visibility so motorist can easily observe signs and traffic barriers.
- Maintain traffic control.
- Reduce risk by removing or pruning leaning and/ or dead trees.
- Provide clearance for SHA owned utility lines and structures.

Purpose

- Maintain clear areas for ice control.
- Provide safe work zones including limbing up and/or pruning back of trees for maintenance activities. Provide safe passage zones for the motoring public and non-motoring public.

Sustainability

- Control invasive species such as Tree of Heaven, Black Cherry and Black Locust.
- Maintain bridge abutments for inspection and for air circulation.
- Maintain vegetation around lights for effective illumination and accessibility to lighting structures.
- Maintain slope safety, stabilization, minimize landscape and other maintenance activities.
- Maintain work zone to and around Intelligent Transportation System cabinet devices and cameras.
- Maintain roadside drainage systems to provide positive drainage to eliminate flooding.
- To maintain the CHART program for telephone and other communication devices.
- To maintain living snow fences.

Aesthetics

- Enhance the attractiveness of natural and reforested areas.
- Maintain Streetscapes to prevent introduction of undesirable and invasive species.
- Perform proper pruning.
- Maintain overlooks and vistas for effective viewing.

Stewardship

- Maintain storm water management ponds to improve aesthetics and drainage.
- Identify, select and promote native and endangered species.
- Improve the health of selected trees through pruning, fertilizing, watering and pest control.
- Provide good relationships with neighbors by preventing introduction and controlling invasive plants.

Maryland Roadside Tree Law

- Be in compliance.
- Know the permitting process and obtain permits where and when necessary.
- Maintain communication with the DNR foresters and LOD personnel.

WOODY VEGETATION MANAGEMENT ON FLAT AREAS

Woody vegetation management on flat areas involves maintenance activities on flat areas and slopes that are less than 3:1 and where routine mowing is not performed. Specific practices involve the management of invasive woody plants and vines in shrub beds, drainage ditches, storm water management ponds, living snow fences, noise walls, right of way fences, and around lights and cabinet devices. When trees within the right of way are to be cut, the local Department of Natural Resource forester shall be contacted to obtain the Roadside Tree Permit.

Invasive Species

Invasive trees, shrubs, and vines shall be controlled in areas of reforestation, meadows and selected wooded areas. This work shall be performed any time of the year when the selected practices can be used to obtain the best results from the treatment.

Hazardous Trees

Hazardous trees are any tree or a tree part that poses a high risk upon failure or fracture for damage or injury to the motoring public, people, adjacent property or power lines. Trees and their parts fail in three basic ways: 1) up rooting; 2) branch fracture; and 3) trunk failure. These trees need be identified and scheduled for pruning, removal or felling. Contact LOD for more information on hazardous trees.

Selected tree snags up to 15 feet in height may be provided for bird and wildlife habitat in designated areas. In other areas brush and stump piles may be constructed to provide similar habitats.

Storm Water Management Ponds

Woody vegetation in storm water management ponds shall be managed so they function according to their design. Trees shall be kept off of embankments.

Residential and Commercial Areas

In residential and commercial areas, selected trees shall be managed for good health and aesthetics. When trees are to be removed in these areas, the adjacent property owner shall be contacted and consulted prior to work so support can be obtained for the removal.

Structures

Access to structures must be maintained where personnel and equipment are required to perform maintenance. Trees shall be kept away from structures as outlined in Tables 1 and 2.

Table 1 Sight Distance as Observed from the Travel Lane.

Distances in feet	Structures
25	Overhead lights and bridges
500 to 1000	Large Signs
500 to 1000	Traffic Control Devices

Table 2 Access and Maintenance Distance from the Center or Edge of the Structure.

Distance in Feet	Structures
5	Cabinet devices
5 to 8	Center of drainage ditches
5 to 17	Traffic barriers
10	Noise walls
15	Utility poles

Tree Setback

Trees shall be planted and maintained at specific distances from the roadway to establish clear zones for recovery. Tree setback is required on Interstate and US routes in unprotected areas where there are no metal or jersey traffic barriers or similar safety devices. Distances are based on posted speed limits and are measured from the traveled pavement edge line. Tree setback to establish clear zones is outlined in Table 3 and illustrated in Drawings 1, 2, and 3.

Table 3 Tree Setback Distance

Posted Speed Limit	Fill Slopes	Cut Slopes		
	6:1 or Flatter	Steeper than 3:1	6:1 to 3:1	Flatter than 6:1
55 MPH Non-Interstate	50 ft.	17 ft.	20 ft.	30 ft.
65 MPH Interstate	50 ft.	17 ft.	25 ft.	30 ft.

Drawing 1 illustrates tree setback and clear zones in flat areas on interstate and primary roads with the above posted speed limits. The clear zone (Area 1) shall consist of grasses and occasional meadows. Trees shall not be permitted to grow on the roadsides in the clear zone. Trees may be planted behind metal traffic barriers, in streetscapes, in residential and commercial areas, and areas with low speed limits.

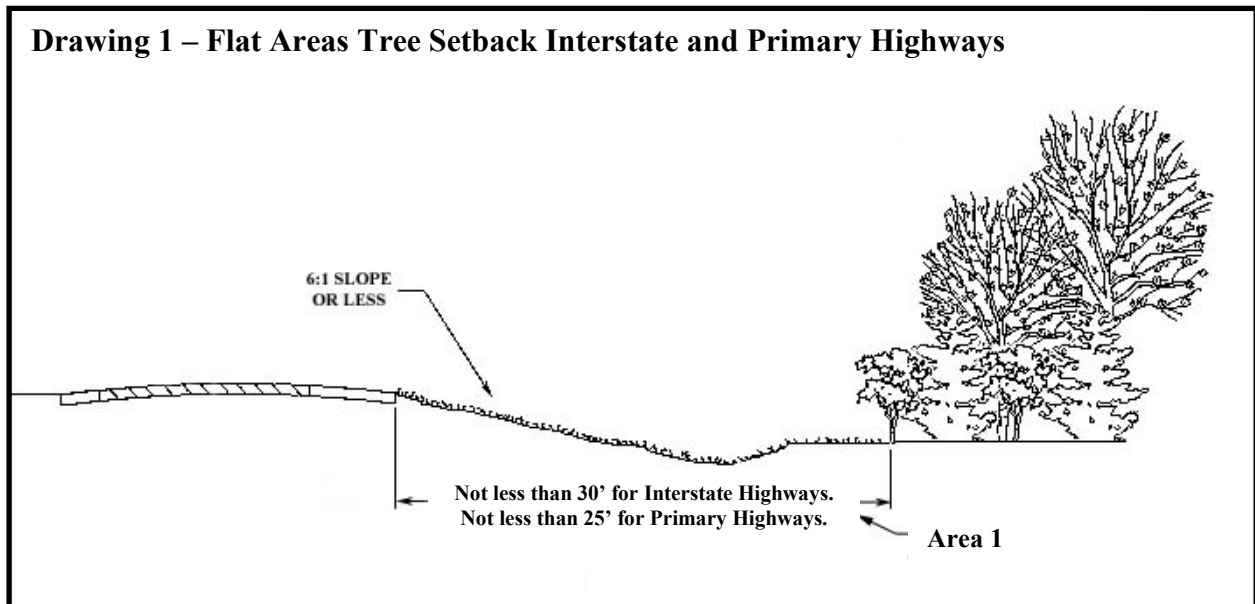

Drawing 2 is a plan view of an interstate highway. Area 1 illustrates tree setback and clear zones along the roadway and around utilities, signs, and light posts.

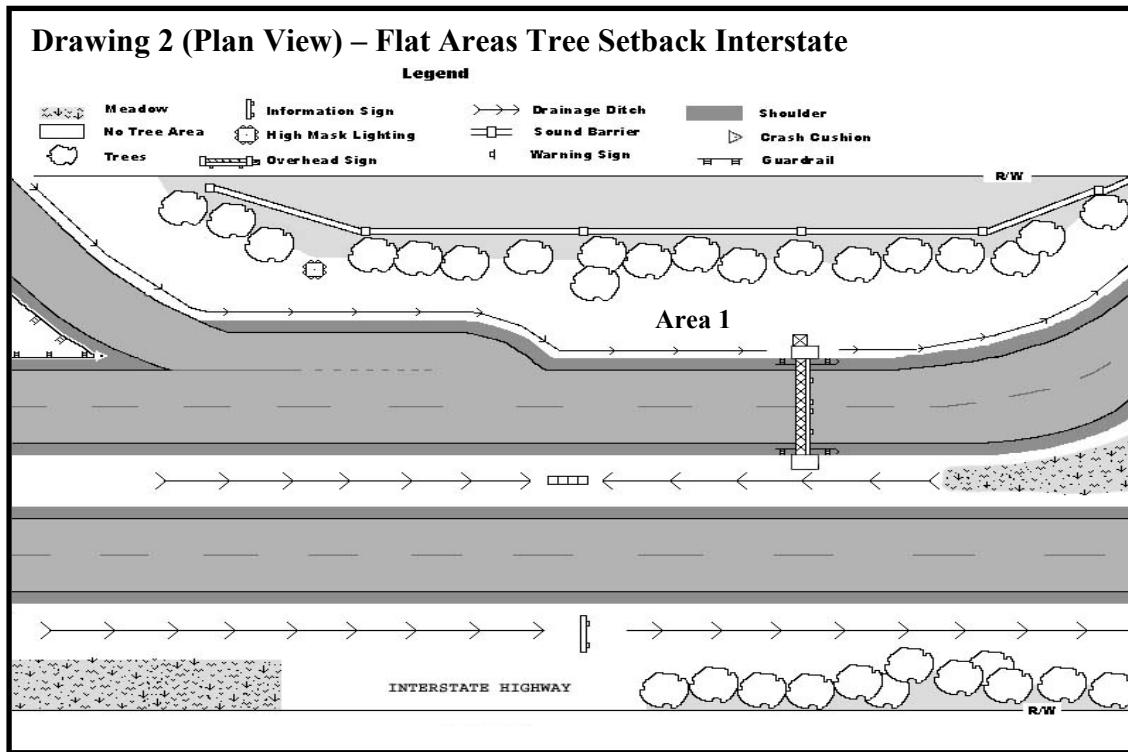

Drawing 3 is a plan view of a primary road. Area 1 illustrates tree setback and clear zones along the roadway and around utilities, signs, and light posts.

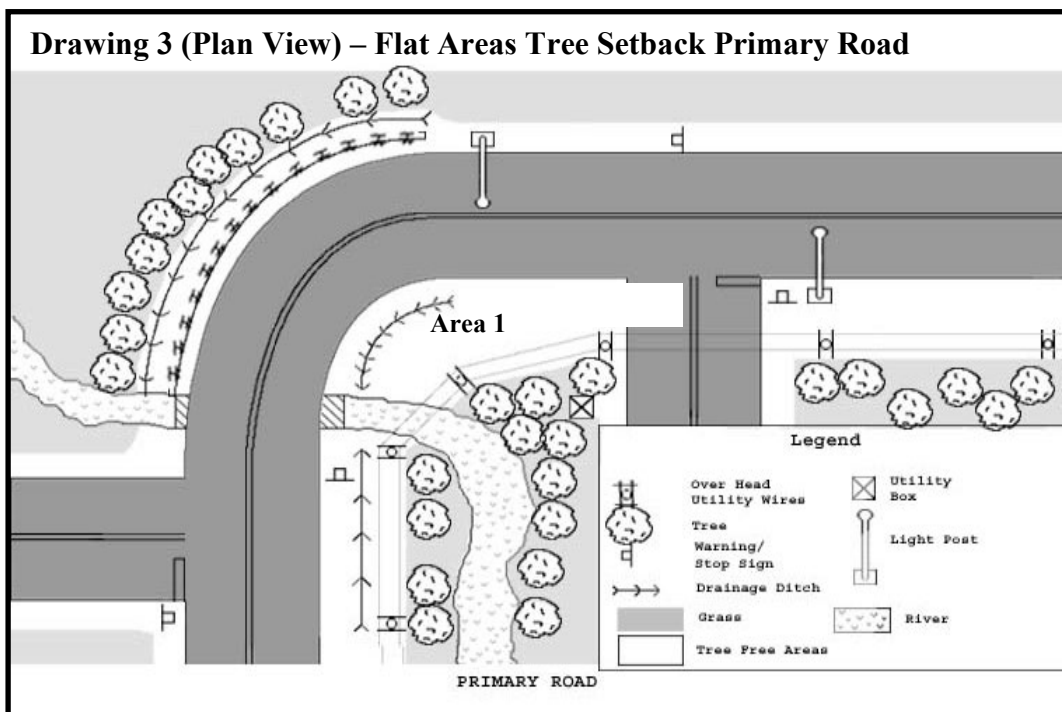

WOODY VEGETATION MANAGEMENT ON SLOPES

Woody Vegetation Management on cut slopes pertains primarily to areas 3:1 or steeper where the toe of cut is within 30 ft of the pavement white edge line and fills slopes of similar gradient. These slopes shall be managed using the standards stated in the following paragraphs.

Slopes shall have black cherry trees removed along residential and commercial areas. Immediately treat cut stumps with a cut stump treatment. Selected slopes shall have Tree of Heaven treated and removed. Selected tree snags may be left for bird and wildlife habitat in designated areas. Trees and vines that block sight distance and official signs shall be removed.

Mow one swath from 2 to 5 ft behind the traffic barriers, located on fill slopes more than 20 ft from the white edge line. Where traffic barriers are less than 20 ft from the white edge line treat the slopes as detailed in Drawing 7. Herbicides will reduce the need for hand trimming under traffic barriers.

Deciduous trees (except Tree of Heaven) are removed by cutting flush with the ground. Immediately after cutting, the stumps shall be treated with a cut stump treatment, as per the "Herbicide Applications Standards". Evergreen trees less than two inches shall have the same treatment.

Where Tree of Heaven (classified as an invasive plant) exists, these standards include its' management. Managing Tree of Heaven involves eliminating the tree where it is growing and reseeded in the spring with appropriate grass or ground cover. Tree of Heaven shall be treated in late summer with a basal stem treatment. Wait 90 days before removing the tree. In some instances the sites should be prepared for reforestation and/or landscaping. Reforestation may be performed in areas 3 or 4 in drawing 5 and area 3 in drawing 7.

Trees cut may be chipped and the chips blown onto the site unless it is in a mowing area. Keep the depth of the chips to a maximum depth of 4 in.

In drawings 4 through 7, cut slopes, bridge abutments and fill slopes, are broken into different areas, based on the areas distance from the highway. Each area is specific in its treatment and intent; in any event, avoid harsh lines of demarcation when mowing and removing vegetation. Blend areas along their edges to reproduce effects found in nature. Any management program must be flexible in its approach or its desired effects will not be realized.

CUT SLOPES (SEE DRAWING 4)

Area 1 – Grasses

Area 1 shall consist of grasses and be mowed. This area allows for minimum sight clearance. When signs, sharp curves or side roads exist, extend the mowing beyond the 5-7 ft. limit to allow for visibility. Maintain grass height between a 3.5 in. minimum and a 10 in. maximum. Herbicides and/or Plant Growth Regulators may be substituted for mowing in this area.

Area 2 - Grasses, Serecia Lespedeza, Crownvetch, Ground Covers, Vines, and Shrubs

Area 2 shall consist of grasses, ground covers, sericia lespedeza, crownvetch, vines and shrubs. The area shall be free of trees, because future road hazards may occur by a tree falling in to the traveled lane or from icy spots occurring in the tree's shadow. All trees shall be cut flush with the ground and the stumps immediately treated with a cut stump treatment. Examples of desirable shrubs which should be left undisturbed are sumac, viburnum, blackberry, chokeberry and dogwood. This area should be treated with herbicides or spot mowed (with an extended arm mower) to control tree growth.

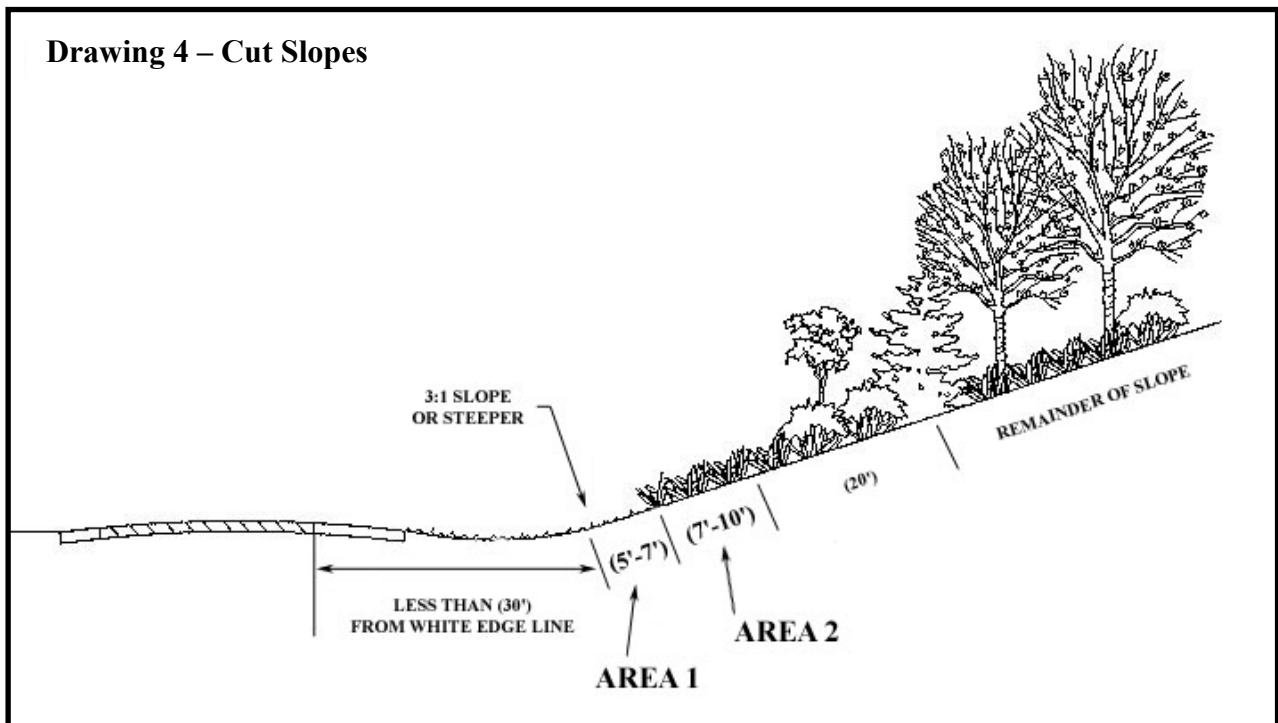

CUT SLOPES (SEE DRAWING 5)

Area 3 - Grasses, Serecia Lespedeza, Crownvetch, Ground Covers, Selected Vines, Shrubs, and Selectively Thinned Trees.

Area 3 shall consist of grasses, serecia lespedeza, crownvetch, ground covers, selected vines, shrubs and selectively thinned trees. Trees shall be thinned so that those remaining are healthy, vigorous and spaced 8 to 15 ft. apart. Whenever possible, desirable trees such as oak, maple, gum, ash, dogwood and pine shall be encouraged to grow in preference to black locust trees. Remove black cherry trees along residential and commercial areas and immediately treat cut stumps with a cut stump treatment. Tree of Heaven shall be treated and removed. It is very important that all removed trees be cut flush to the ground and the stumps be treated immediately with a cut stump treatment. Pruning to improve the quality of a tree shall be performed by trained personnel.

Area 4 - Grasses, Serecia Lespedeza, Crownvetch, Ground Covers, Vines, Shrubs, and Trees.

Area 4 shall consist of grasses, serecia lespedeza, cownvetch, ground covers, vines, shrubs, and trees and be allowed to grow naturally. Remove black cherry trees along residential and commercial areas and immediately treat cut stumps with a cut stump treatment. Treat Tree of Heaven and remove.

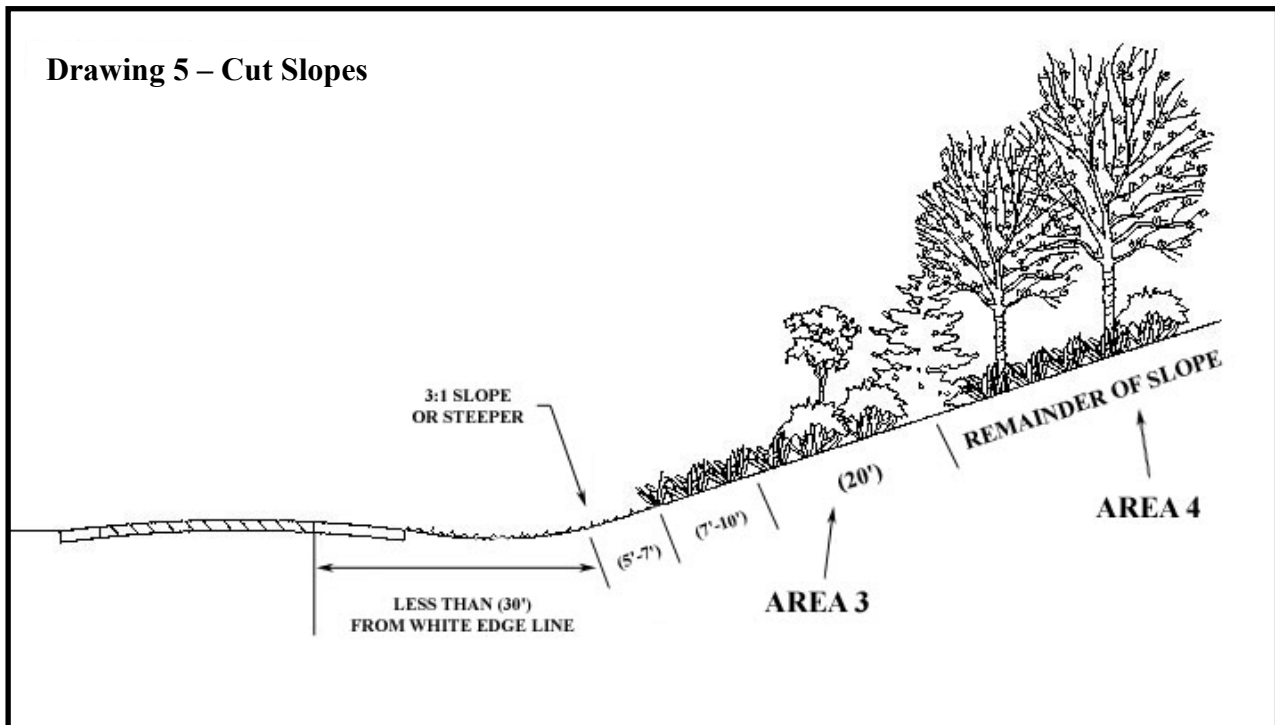

Bridge Abutments

BRIDGE ABUTMENTS (SEE DRAWING 6)

Area 1 – Grasses

Area 1 shall consist of grasses and be managed to control invasive species. Remove trees and shrubs closer than 10 ft. to bridge structures after approval by the Landscape Operations Division. Trees removed shall be cut flush with the ground and the stumps immediately treated with a cut stump treatment.

Area 2 - Grasses, Serecia Lespedeza, Crownvetch, Ground Covers, Selected Vines, and Desirable Woody Plant Material

Area 2 shall consist of grasses, serecia lespedeza, crownvetch, ground covers, selected vines and desirable woody plant material. Some examples of desirable plant to be left undisturbed are sumac, viburnum and forsythia. Remove trees closer than 30 ft. to bridge structures after approval by the Landscape Operations Division.

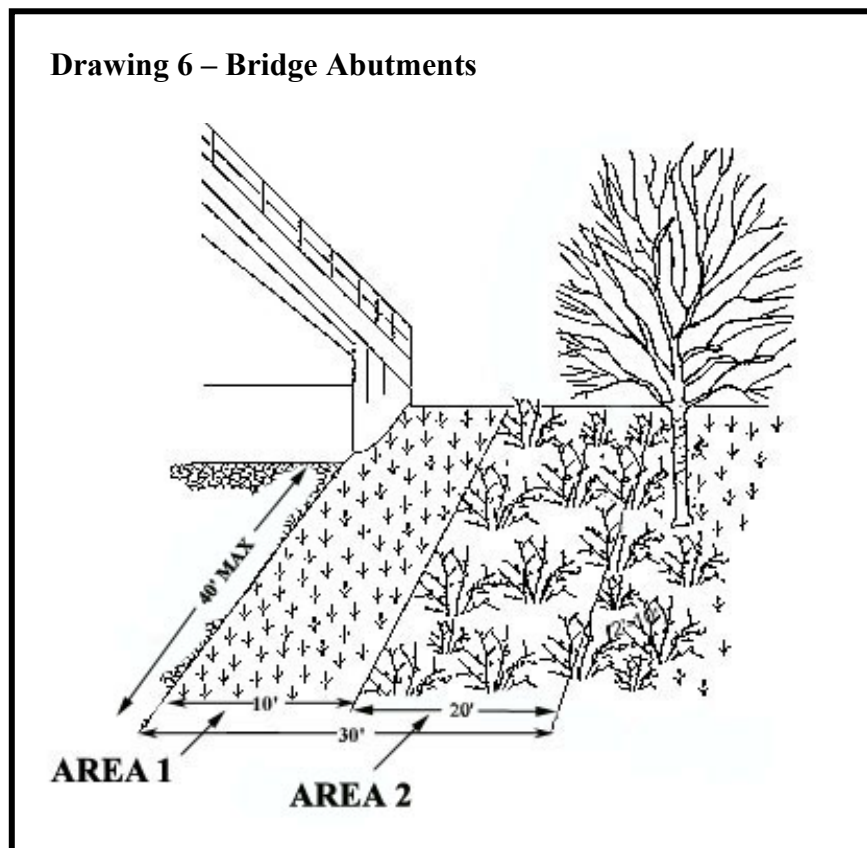

FILL SLOPES (SEE DRAWING 7)

Area 1 – Grasses

Area 1 shall consist of grasses and be mowed.

Area 2 - Grasses, Serecia Lespedeza, Crownvetch, Ground Covers, Selected Vines, and Shrubs

Area 2 shall consist of grasses, serecia lespedeza, crownvetch, ground covers, selected vines, and shrubs. The area shall be free of trees, because future road hazards may occur by a tree falling into the traveled lane or from icy spots occurring in the tree's shadow. All trees shall be cut flush with ground and the stumps will immediately be treated with a cut stump treatment. Examples of desirable shrubs occurring and to be left undisturbed are sumac, viburnum, blackberry, chokeberry, dogwood, and forsythia.

Area 3 - Grasses, Serecia Lespedeza, Crownvetch, Ground Covers, Vines, Shrubs, and Trees.

Area 3 shall consist of grasses, serecia lespedeza, crownvetch, ground covers, vines, shrubs, and trees and be allowed to grow naturally. Remove black cherry trees along residential and commercial areas and immediately treat cut stumps with a cut stump treatment. Treat Tree of Heaven and remove.

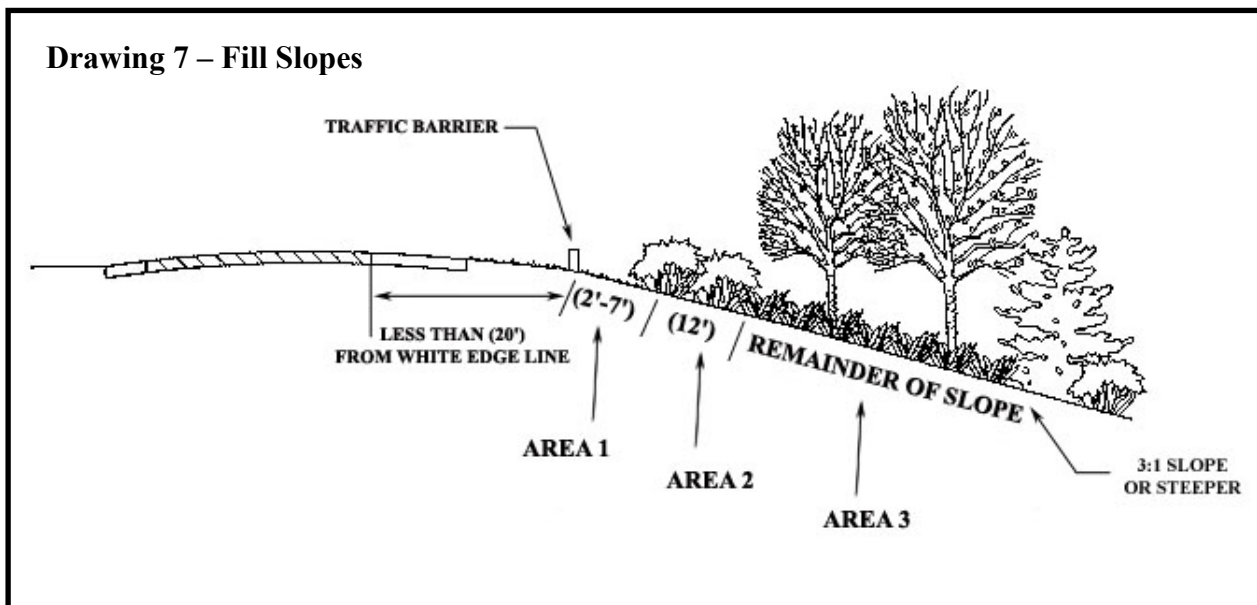

TREE LAWS

The following tree laws, regulations, and guidelines can provide additional information to assist in roadside tree care. The laws can be found in the Annotated Code of Maryland and the regulations in Code of Maryland Regulations (COMAR).

- Roadside Tree Care Law** Natural Resources Article Title 5, Chapters 209 and 406
- Tree Expert Licensing Law** Natural Resources Article Title 5, Chapters 415-423
- Roadside Tree Care Regulations** Title 08 DEPARTMENT OF NATURAL RESOURCES Subtitle 07 FORESTS AND PARKS Chapter 07
- Tree Care Licensing Regulations** Title 08 DEPARTMENT OF NATURAL RESOURCES Subtitle 07 FORESTS AND PARKS Chapter 02
- Risk Tree Assessment Guidelines** available from The Maryland Department of Natural Resources

Any questions or concerns about the information contained in this section can be directed to the Landscape Operations Division.

There are two Roadside Tree Permit Application Forms which are specific to the type of tree care proposed. The permits are as follows:

- Roadside Tree Law Permit Application for Public Agencies
- Roadside Tree Law Permit Application for Individual

The **Application for Roadside Tree Permit – Public Agency (RTPA)** is issued to each shop to cover a period of one year and provides for general maintenance work. This permit covers tree planting and maintenance activities outlined in this document, as well as, selected tree removal (see permit application for specific conditions), crown raising, crown thinning, root pruning, pesticide applications for weed, insect and disease control, and other activities deemed appropriate by the Maryland Department of Natural Resources – Forest Service (DNR-FS).

The **Application for Roadside Tree Permit – Individual (RTI)** is issued to a shop when needed for a site specific project such as small sections of road, interchanges, and facilities for tree removals and/or major pruning and trimming. Individual applications are reviewed on a case by case basis by DNR-FS.

Roadside Tree Law Application for Permit

Maryland DNR-Forest Service ROADSIDE TREE LAW
APPLICATION FOR PERMIT-PUBLIC AGENCY
(RTPA)

Instructions:

Completing the application:

Date Entered:

(1.) Please complete Section A. (2.) Review and sign Section B. (3.) Mail to the Forest Service.

SECTION A: To Be Completed By Applicant:

I. Applicant First Name: _____ Applicant Last Name: _____

Applicant Phone: _____ Applicant Fax: _____

Tree Care Expert: _____

Agency Name: _____

Agency Address: _____

Agency City: _____ Agency State: _____ Agency Zip: _____

// CHECK ALL ACTIVITIES BEING REQUESTED UNDER THIS PERMIT: Application for permit is hereby made to:

1. Selected tree removal:

Cut any dead trees or any tree that is uprooted or its branches broken which may create a hazard to traveled lanes of the highway or street.

2. Crown Raising:

Prune trees to remove low hanging branches which may impede the free flow of traffic and to improve sight distance at hazardous intersections. Trees must be pruned to Roadside Tree Standards (COMAR 08.07.02.07).

3. Crown cleaning, crown thinning crown reduction:

Prune trees to carry out a planned tree maintenance program which is designed to improve the health, vigor, and general appearance of trees; prune ornamental tree plantings to improve general health and appearance. Trees must be pruned to Roadside Tree Standards (COMAR 08.07.02.07.).

4. Slope Management:

Perform selective cutting of live growth on slopes adjacent to highways in accordance with "State Highway Administration Slope Management Standards" to improve highway safety, aesthetics, and for beneficial control of vegetation.

NOTE: if checking 5a Or 5b, please provide your MDA Public Agency Certificate number or contractor's MDA Commercial Applicator Certificate number and attach copy of certificate. ITEMS 5a and 5b WILL NOT BE APPROVED WITHOUT THESE ITEMS. MDA Certificate #:

5a. Pesticide application-weed pests:

Perform selective application of herbicides in accordance with Maryland State Highway Administration "Herbicide Application Standards" to improve highway safety, aesthetics, and for beneficial control of vegetation. Pesticide application must conform to Roadside Tree standards (COMAR 08.07.02.08.).

5b. Pesticide application-insect and disease pests:

Perform selective application of insecticides, fungicides, and other chemicals for the control of specific insects and diseases which are detrimental to the health and general appearance of roadside trees. Pesticide application must conform to Roadside Tree standards (COMAR 08.07.02.08.).

6. Tree Planting:

Perform new and replacement plantings in accordance with the policies of MD DNR and MD SHA. Plantings must conform to Roadside Tree standards (COMAR 08.07.02.09.).

7. Infrastructure construction or maintenance including round disturbance:

Undertake construction activities which may impact the roots, stem, or shoots of Roadside Trees, including root pruning. Activities must conform to Roadside Tree standards (COMAR 08.07.02.07.C and D.).

8. Other:

Roadside Tree Law Application for Permit

Page 2 of 2

III. Contractor Performing the Tree Care Work (if applicable)

Company: _____
First Name: _____ Last Name: _____
Phone: _____ Fax: _____

Licensed Tree Expert (person providing supervision per the requested permit):

First Name: _____ Last Name: _____
License# _____ Phone: _____

SECTION B: To Be Reviewed and Sighed by the Applicant

Terms and Conditions

I. In performing the work herein authorized by this permit the foreman responsible for supervision shall first receive preliminary instruction from a Forest Warden or an approved Roadside Tree Care Expert as to how the work shall be performed, and further, during or after the performance of the work the character of the treatment accomplished may be subject to inspection by Forest Wardens or approved Roadside Tree Care Experts. Corrections shall be made to any tree conditions deemed unsatisfactory. No work shall be performed without the presence of the foreman or other employee who has been personally instructed concerning the treatment to be given to the specific trees receiving treatment. Pruning for any purpose shall be done in accordance with Roadside Tree and ANSI A300 standards.

This permit authorizes treatment only of those trees growing within a right - of - way of a public highway. The work may be suspended by order of the Forest Warden upon failure or refusal of the permittee to perform in accordance with the rules and regulations *Of* the Maryland Department *Of* Natural Resources-Forest Service.

This permit is granted under the authority *Of* the Annotated Code *Of* Maryland, under Title 5, Subtitle 406, which places the care and protection of all trees growing within the right - of - way of a public road or between the curb and property lines *Of* any street in any incorporated town in Maryland under authority *Of* the Maryland Department *Of* Natural Resources-Forest Service. This permit in no way contravenes the rights *Of* property owners to restrict or prevent the pruning or cutting *Of* trees upon their own properties, except that trees covered by this permit may not be treated in any way other than as herein specified.

II. I affirm that I will comply with all conditions of this application and resulting permit, of the Roadside Tree Permit for which I am applying, of Annotated Code of Maryland Natural Resources Article 5-401 et. seq., and of COMAR 08.07.02. et. seq.

III. Applicant's Signature: _____ Date: _____

DNR-FS Permit Application Evaluation

For official use only

Reviewer First Name: _____ Reviewer Last Name: _____ Title: _____

Office: _____ Address: _____ City: _____ State: _____ Zip: _____

ReviewDate: _____ County: _____ Region: _____ Project: _____

ReviewerComments: _____ 5

Response to request - select one

Approval _____ RTPA# _____ Create Permit.

Denial: The application is denied due to the following

Roadside Tree Law Application for Permit

Maryland DNR-Forest Service ROADSIDE TREE LAW
APPLICATION FOR PERMIT-PUBLIC AGENCY
(RTPA)

Instructions:

Completing the application:

Date Entered:

(1.) Please complete Section A. (2.) Review and sign Section B. (3.) Mail to the Forest Service.

SECTION A: To Be Completed By Applicant:

I. Applicant First Name: SHOP APPLYING Applicant Last Name: N/A
Applicant Phone: SHOP PHONE NO# Applicant Fax: SHOP FAX NO#
Tree Care Expert: TREE CARE EXPERT CERTIFICATE HOLDER
Agency Name: STATE HIGHWAY ADMINISTRATION
Agency Address: SHOP ADDRESS
Agency City: _____ Agency State: MD Agency Zip: _____

// CHECK ALL ACTIVITIES BEING REQUESTED UNDER THIS PERMIT: Application for permit is hereby made to:

1. Selected tree removal:

Cut any dead trees or any tree that is uprooted or its branches broken which may create a hazard to traveled lanes of the highway or street.

2. Crown Raising:

Prune trees to remove low hanging branches which may impede the free flow of traffic and to improve sight distance at hazardous intersections. Trees must be pruned to Roadside Tree Standards (COMAR 08.07.02.07).

3. Crown cleaning, crown thinning crown reduction:

Prune trees to carry out a planned tree maintenance program which is designed to improve the health, vigor, and general appearance of trees; prune ornamental tree plantings to improve general health and appearance. Trees must be pruned to Roadside Tree Standards (COMAR 08.07.02.07).

4. Slope Management:

Perform selective cutting of live growth on slopes adjacent to highways in accordance with "State Highway Administration Slope Management Standards" to improve highway safety, aesthetics, and for beneficial control of vegetation.

NOTE: if checking 5a Or 5b, please provide your MDA Public Agency Certificate number or contractor's MDA commercial Applicator Certificate number and attach copy of certificate. ITEMS 5a and 5b WILL NOT BE APPROVED WITHOUT THESE ITEMS. MDA Certificate #:

5a. Pesticide application- weed pests:

Perform selective application of herbicides in accordance with Maryland State Highway Administration "Herbicide Application Standards" to improve highway safety, aesthetics, and for beneficial control of vegetation. Pesticide application must conform to Roadside Tree standards (COMAR 08.07.02.08.).

5b. Pesticide application-insect and disease pests:

Perform selective application of insecticides, fungicides, and other chemicals for the control of specific insects and diseases which are detrimental to the health and general appearance of roadside trees. Pesticide application must conform to Roadside Tree standards (COMAR 08.07.02.08.).

6. Tree Planting:

Perform new and replacement plantings in accordance with the policies of MD DNR and MD SHA. Plantings must conform to Roadside Tree standards (COMAR 08.07.02.09.).

7. Infrastructure construction or maintenance including round disturbance:

Undertake construction activities which may impact the roots, stem, or shoots of Roadside Trees, including root pruning. Activities must conform to Roadside Tree standards (COMAR 08.07.02.07.C.and D.).

8. Other:

Roadside Tree Law Application for Permit

Page 2 of 2

III. Contractor Performing the Tree Care Work (if applicable)

Company: TO BE DETERMINED (TBD)
First Name: _____ Last Name: _____
Phone: _____ Fax: _____

Licensed Tree Expert (person providing supervision per the requested permit):

First Name: SHOP/LOD/CONTRACTOR or TBD Last Name: _____
License# _____ Phone: _____

SECTION B: To Be Reviewed and Signed by the Applicant Terms and Conditions

1. In performing the work herein authorized by this permit the foreman responsible for supervision shall first receive preliminary instruction from a Forest Warden or an approved Roadside Tree Care Expert as to how the work shall be performed, and further, during or after the performance of the work the character of the treatment accomplished may be subject to inspection by Forest Wardens or approved Roadside Tree Care Experts. Corrections shall be made to any tree conditions deemed unsatisfactory. No work shall be performed without the presence of the foreman or other employee who has been personally instructed concerning the treatment to be given to the specific trees receiving treatment. Pruning for any purpose shall be done in accordance with Roadside Tree and ANSI A300 standards.

This permit authorizes treatment only of those trees growing within a right - of - way of a public highway. The work may be suspended by order of the Forest Warden upon failure or refusal of the permittee to perform in accordance with the rules and regulations of the Maryland Department of Natural Resources-Forest Service.

This permit is granted under the authority of the Annotated Code of Maryland, under Title 5, Subtitle 406, which places the care and protection of all trees growing within the right - of - way of a public road or between the curb and property lines of any street in any incorporated town in Maryland under authority of the Maryland Department of Natural Resources-Forest Service. This permit in no way contravenes the rights of property owners to restrict or prevent the pruning or cutting of trees upon their own properties, except that trees covered by this permit may not be treated in any way other than as herein specified.

II. I affirm that I will comply with all conditions of this application and resulting permit, of the Roadside Tree Permit for which I am applying, of Annotated Code of Maryland Natural Resources Article 5-401 et. seq., and of COMAR 08.07.02. et. seq.

III. Applicant's Signature: RESIDENT MAINTENANCE ENGINEER Date: _____

DNR-FS Permit Application Evaluation For official use only

Reviewer First Name: _____ Reviewer Last Name: _____ Title: _____

Office: _____ Address: _____ City: _____ State: _____ Zip: _____

ReviewDate: _____ County: _____ Region: _____ Project: _____

ReviewerComments: _____ 5

Response to request - select one

Approval _____ RTPA# _____ Create Permit.

Denial: The application is denied due to the following

Roadside Tree Law Application for Permit



Maryland DNR-Forest Service **ROADSIDE TREE LAW**
APPLICATION FOR PERMIT-INDIVIDUAL (RTI)

Instructions:

Completing the application:

® Please complete Section A. © Review and sign Section B. ™ Mail to the address listed in Section C.

SECTION A.: To Be Completed By Applicant :

I. Applicant's Name: _____
Name/Company: _____ Contract/Job #: _____
Address (Street): _____
(City, State, Zip): _____
Contact Name: _____ Phone: () - _____ Fax: () - _____

II. Application for permit is hereby made to: _____

III. Contractor Performing the Tree Care Work

Company: _____
Contract Name: _____ Phone: () - _____ Fax: () - _____
Licensed Tree Expert (person providing supervision per the requested permit):
Name: _____ Lic. #: _____ Day Phone: () - _____

SECTION B.: To Be Reviewed and Signed by the Applicant

Terms and Conditions

I. Prior to the commencement of any work performed under this permit, the applicant must contact the appropriate agency charged with maintaining the roadway that the work is to occur on (ie. State Highway Administration, county or municipal roads departments, etc.) If any work will occur within 10' of an overhead utility line, the applicant must coordinate with the applicable utility(s). If any ground disturbance will occur, the applicant must contact Miss Utility to locate underground utilities.

II. I affirm that I will comply with all conditions of this application and resulting permit, of the Roadside Tree Permit for which I am applying, of Annotated Code of Maryland Natural Resources Article 5-401 et. seq., and of COMAR 08.07.02. et. seq.

III. Applicant's Signature: _____ Date: _____

SECTION C.: DNR RESPONSE TO REQUEST

Request Approved

Mail application to:

Request Denied

Direct written appeal to:

Roadside Tree Law Application for Permit



Maryland DNR-Forest Service **ROADSIDE TREE LAW**
APPLICATION FOR PERMIT-INDIVIDUAL
(RTI)

Instructions:

Completing the application:

Ⓜ Please complete Section A. Ⓞ Review and sign Section B. ™ Mail to the address listed in Section C.

SECTION A.: To Be Completed By Applicant :

I. Applicant's Name: State Highway Administration

Name/Company: Shop Contract/Job #: _____

Address (Street): Shop Location

(City, State, Zip): _____

Contact Name: Resident Maintenance Engineer Name Phone: () - _____ Fax: () - _____

II. Application for permit is hereby made to: Description of Tree Work

III. Contractor Performing the Tree Care Work

Company: To Be Determined

Contract Name: _____ Phone: () - _____ Fax: () - _____

Licensed Tree Expert (person providing supervision per the requested permit):

Name: _____ Lic. #: _____ Day Phone: () - _____

SECTION B.: To Be Reviewed and Signed by the Applicant

Terms and Conditions

I. Prior to the commencement of any work performed under this permit, the applicant must contact the appropriate agency charged with maintaining the roadway that the work is to occur on (ie. State Highway Administration, county or municipal roads departments, etc.) If any work will occur within 10' of an overhead utility line, the applicant must coordinate with the applicable utility(s). If any ground disturbance will occur, the applicant must contact Miss Utility to locate underground utilities.

II. I affirm that I will comply with all conditions of this application and resulting permit, of the Roadside Tree Permit for which I am applying, of Annotated Code of Maryland Natural Resources Article 5-401 et. seq., and of COMAR 08.07.02. et. seq.

III. Applicant's Signature: Resident Maintenance Engineer Date: _____

SECTION C.: DNR RESPONSE TO REQUEST

Request Approved

Mail application to:

Request Denied

Direct written appeal to:

PAGE LEFT BLANK

Wildflower Program

INTRODUCTION

The Administration's Wildflower Program started in 1986 to reduce mowing, lower air pollution, provide wildlife habitat, and enhance the aesthetics of highways. The program has been very popular over the years resulting in over 300 acres of wildflowers being seeded along the roadsides and in medians.

The wildflowers not only bring color to the interstate and primary highways, they also assist in reducing roadside maintenance. Generally, seeding takes place in the fall for spring/summer color and in the late spring/early summer for summer/fall color. Seed mixes include annuals and perennial wildflowers. In addition to establishing wildflower sites, SHA also encourages the management of naturally occurring wildflowers.

SITE SELECTION

Visibility to the motoring public is very important. Sites should be selected to optimize visibility. Sight distance is one of the most important things to consider when selecting wildflower sites. Other considerations include the following:

- Stay out of areas used for utility access.
- Avoid seeding in front of road signs, deer reflectors or other visual driving aids.
- Keep away from intersections to avoid blocking sight distance. Use a low growing wildflower mixture when site distance is a factor.
- Relatively flat, open areas in full sun are preferred.
- Evaluate existing vegetation within the site being considered. Develop a course of action in order to correct existing vegetation problems. Avoid areas with noxious or invasive plants.
- Sites should have adequate sunlight and proper drainage.
- Easy access for maintenance should be considered. Sites should be approved by the Resident Maintenance Engineer.
- Cooperative wildflower projects should be coordinated through SHA's Partnership Planting Coordinator.

SITE LAYOUT

When laying out wildflower sites, setbacks from the roadway, slopes, ditches and intersections must be considered. A mow swath is desired along the front edge of wildflower site and in drainage swales. There should be a turf strip of 6 to 8 feet to accommodate the maintenance equipment. Global Positioning System reference points could be referred to, when available. A sketch book diagram should be developed for each site. Measurements will be in square yards and converted to acres.

Wildflower Program

SEDIMENT AND EROSION CONTROL

Sediment and erosion control must be considered when establishing wildflowers. The “General Notes for Erosion and Sediment Control and Details for Areas of Wildflower Establishment” found on pages 5.6-5.14 provide acceptable controls. When deviating from construction details, additional sediment and erosion control measures will be necessary. Drain inlet structure clearance must be respected. Avoid seeding within 75 feet of the upgrade side and 25 feet from the downgrade side of any inlet structure. Maintaining an adjacent turf buffer, will control erosion and improve aesthetics.

SITE PREPARATION

Mowing

Mowing is the first step in site preparation. The vegetation should be mowed to a height of 2-4 inches prior to applying herbicides, tilling and/or seeding. Coordination must be made between mowing and herbicide applications.

Weed Control

Weed control is essential for the successful establishment of wildflowers. The first step should be to determine unwanted vegetation and develop control methods. The first herbicide application should be directed toward complete eradication of unwanted vegetation. Two growing seasons may be needed for optimum results when invasive species exist. Good site preparation will reduce initial weed competition.

A frequently used postemergence herbicide is Roundup Pro Concentrate (glyphosate with surfactant) for non-selective and non-residual weed and grass control. 2,4-D is used for postemergence broadleaf weed control. Garlon 3A is used for hard to control broadleaf weeds and woody vegetation. Transline is used for spot thistle control. Pathfinder II RTU (ready to use) is a combination of triclopyr, vegetable oil and dye and it is used as a basal stem cut stump treatment on trees and shrubs.

A second herbicide application prior to seeding may be needed to eradicate hard-to-kill or newly germinated weeds. This second application should be Roundup Pro Concentrate applied after germination of new weeds and 2 to 3 weeks prior to seeding.

Soil

Soil shall be moderate to well drained. It should have a soil pH between 6.0 and 7.5 and an organic matter content of at least 1.5%. Soil may be improved by adding soil amendments based on soil tests.

Soil Amendments

Soil amendments may be added to the soil as follows:



Wildflower Program

- ❑ **Compost** - Sandy and heavy clay soils will benefit from the addition of compost to improve soil structure, enhance nutrients, and help water holding capacity. Compost shall meet SHA specifications. When adding compost, spread ¼ inch thickness for biosolid compost and ½ inch thickness for tree leaf compost over entire planting area. Immediately after spreading, the compost shall be tilled to a depth of 3 to 4 inches. Compacting shall be done within one day after tilling.
- ❑ **Nutrient Management Plan (NMP)** – A NMP is developed, based on soil test results, to determine the proper amount of limestone and fertilizer required for the establishment of wildflowers.
 - **Limestone** – Limestone is used to reduce soil acidity. Limestone should be added or to the site prior to cultivation so it is incorporate into the root zone.
 - **Fertilizer** –A 10-22-22 (50% nitrogen from slow release 38-0-0 ureaform) fertilizer is used to raise the phosphorus and potash levels. Fertilizer should be added immediately before or after seeding. The fertilizer may be applied using a cyclone type fertilizer spreader or a hydroseeder. If compost is being added avoid fertilizing at this time.

Tilling

Tilling is utilized when the soil is compacted to improve soil structure and to prepare a seedbed. The soil should be tilled to a depth of 2 to 3 inches if not incorporating compost. Soil amendments should be thoroughly incorporated. Level the soil surface prior to seeding. When the soil is dry and /or fluffy it should be rolled or cultipacked.



WHEN TO SEED

Wildflowers do best when seeded in the spring or the fall. Fall seeding should be delayed until November to February to prevent early germination of seedlings that would be subject to winter damage. Fall seeding can take advantage of winter rain or snow and colder soil temperatures. Seeding should be late enough to prevent germination from occurring until the following spring, otherwise the seedlings will be lost to winter damage. Time for establishment is needed for seedlings to bloom the following spring and summer.



Wildflower Program

Spring seeding from March to late April allows for successful germination of certain tender annuals such as Cosmos that are not reliable in fall seeding. Spring seeding should be completed as soon as the ground is workable to take advantage of the spring rainfall. Spring seeded perennials generally will not flower until the second growing season. Late summer and fall blooming annuals can be seeded in late spring or early summer. Again moisture needs are still critical for adequate growth and flowering.

SEED APPLICATION

The size of the site and the topography will determine what type of seeder should be used. The four methods used for seeding wildflowers are broadcast, no-till drill, or till-drill and hydroseeding.

- A **hand cyclone seeder** is recommended for areas smaller than a $\frac{1}{4}$ of an acre. If this method is used a carrier such as kitty litter should be added to the seed at 1 to 2 parts to 1 part seed. Lightly rake-in the seed.
- Specially designed wildflower **drill seeders** with three different sized seed boxes are good to use on larger flat areas. Drill selective seed to a depth of $\frac{1}{4}$ inch. If the site was tilled the soil should be firmed with a cultipacker to maximize seed to soil contact and conserve moisture.
- Hydroseeders** can be used for slopes and rocky terrain. Hydromulch is the preferred mulch since it has no foreign seeds. Seed germination is higher when applied with only 5 to 10% of the required amount of hydromulch, and the remaining applied in a second step. This procedure ensures better seed/soil contact, otherwise a high percent of the seed fails to germinate, since it stays suspended in the dry hydromulch. Minimize the amount of time that seed is circulated through the pumps prior to the seeding application. Seed may be damaged due to over-circulation.

PLUG INSTALLATION

Wildflower rooted plugs offer an alternative for seeding. Certain wildflowers such as butterfly weed, New England Aster, and New York Ironweed become established quicker from planting plugs. Five inch deep plugs have a high transplant survival rate and are more reliable than seed. Plugs will reach flowering size faster than seeded wildflowers. The site should be prepared the same as for seeding.

SITE MAINTENANCE

During wildflower establishment, the site will require as much maintenance as traditional plantings. The site should be evaluated during the growing season to determine what maintenance is needed. Some conditions must be dealt with promptly while others may be corrected later. There are two areas of maintenance that require consideration:

Wildflower Program

- ❑ **Weed control** - A preemergence herbicide application is recommended only for established perennial wildflower sites when no overseeding is scheduled and prior to annual weed seed germination. This herbicide application can also be applied after wildflower seedlings have become established prior to weed seed germination. Endurance, Surflan AS, and Pendulum WDG can be used for preemergence weed control only after all wildflower seed has germinated.

A postemergence herbicide such as Assure II, Fusilide, Ornamec and Plateau may be necessary for additional weed control. Always, refer “SHA Herbicide Application Standards “and the product labels for guidance.

- ❑ **Fall mowing** - Mow annual wildflower sites after blooming has finished. Mow perennial wildflower sites late fall to control woody vegetation and unsightly weeds. If desired, leave perennial wildflower sites unmowed to over the winter to provide food and shelter for wildlife. If woody vegetation and unsightly weeds exist, mow in fall to a height of 6-8 inches.

General Notes and Construction Details

GENERAL NOTES

EROSION AND SEDIMENT CONTROL FOR AREAS OF WILDFLOWER ESTABLISHMENT

- EROSION AND SEDIMENT CONTROL WOULD PERTAIN TO WILDFLOWER AREAS WHERE TILLAGE IS PERFORMED AND WHERE NON-TILL IS PERFORMED IN SENSITIVE AREAS.
- SENSITIVE AREAS WOULD PERTAIN TO THE FOLLOWING: HIGHLY ERODABLE SOILS, WATERSHED AREAS, PONDS AND RESERVIORS, AND HIGHLY VISIBLE AREAS.
- ON SLOPES 6:1 TO LESS THAN 4:1 MULCH AREAS WITHIN 3 WORKING DAYS OF DISTURBANCE AND ON SLOPES 4:1 AND STEEPER MULCH WITHIN 48 HOURS.
- ON SLOPES 4:1 AND STEEPER INSTALL A SILT FENCE ON DOWNSTREAM SIDE OF THE SLOPE PRIOR TO DISTURBANCE.
- DITCHES OR SWALES SHALL HAVE A 7' TURF BUFFER ZONE ON BOTH SIDES OF THE DITCH CENTERLINE.
- INLETS SHALL HAVE A TURF BUFFER ZONE OF 75 FEET ON THE UPGRADE SIDE OF THE INLET AND 25 FEET ON THE DOWNGRADE SIDE OF THE INLET. IF THE DITCH CHANNEL HAS A GRADE GREATER THAN 3 PERCENT A SILT FENCE SHALL BE INSTALLED AROUND THE INLET OR SEDIMENT LOG.
- SILT FENCE TO MEET THE REQUIREMENTS OF CLASS F- GEOTEXTILE

NOT TO SCALE



OCTOBER 2003

Maryland Department of Transportation STATE HIGHWAY ADMINISTRATION

DETAILS

SPECIAL PROVISION - EROSION AND SEDIMENT CONTROL
FOR AREAS OF WILDFLOWER ESTABLISHMENT

1 OF 9

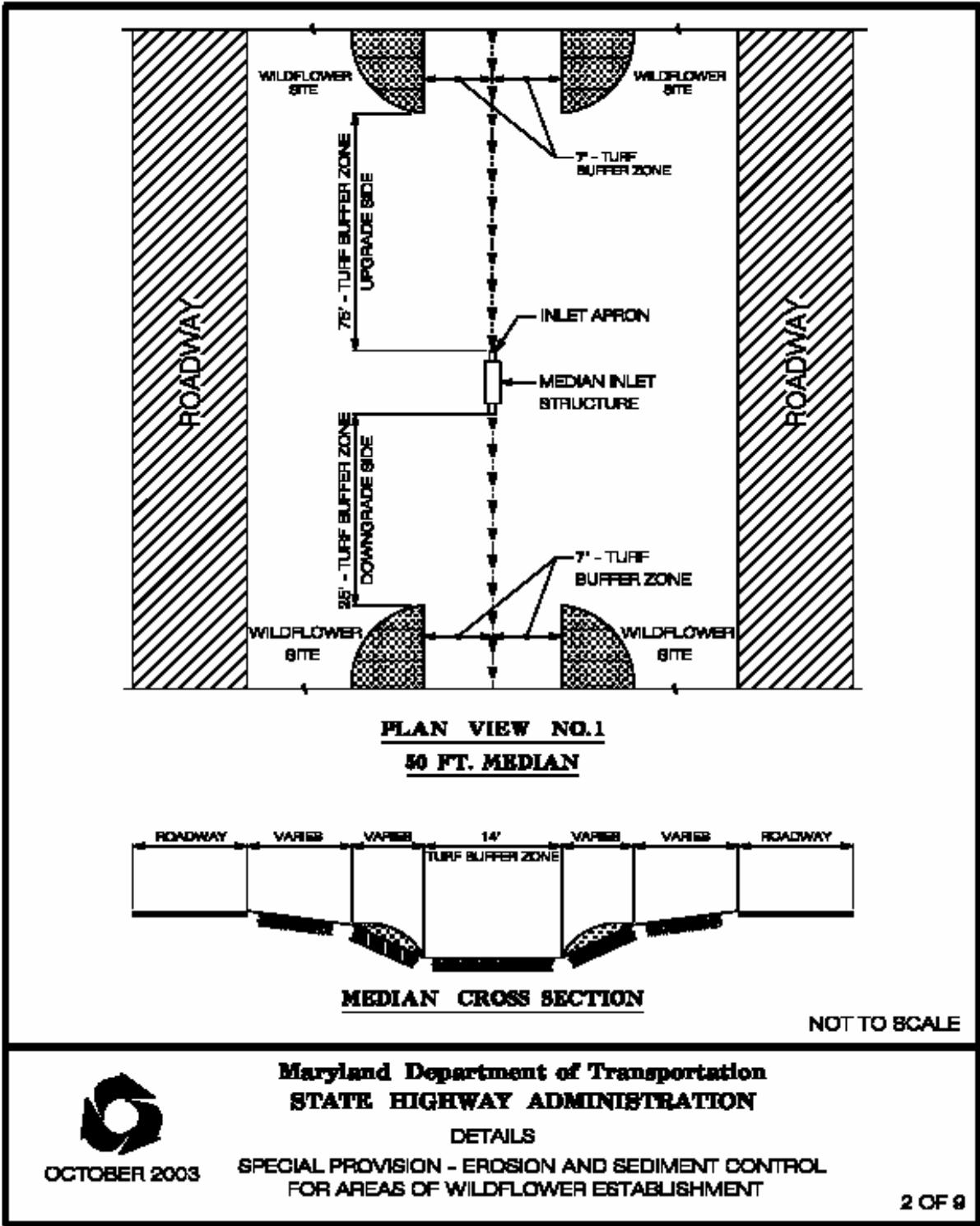

OCTOBER 2003

Maryland Department of Transportation
STATE HIGHWAY ADMINISTRATION

DETAILS

SPECIAL PROVISION - EROSION AND SEDIMENT CONTROL
FOR AREAS OF WILDFLOWER ESTABLISHMENT

2 OF 9

Construction Detail

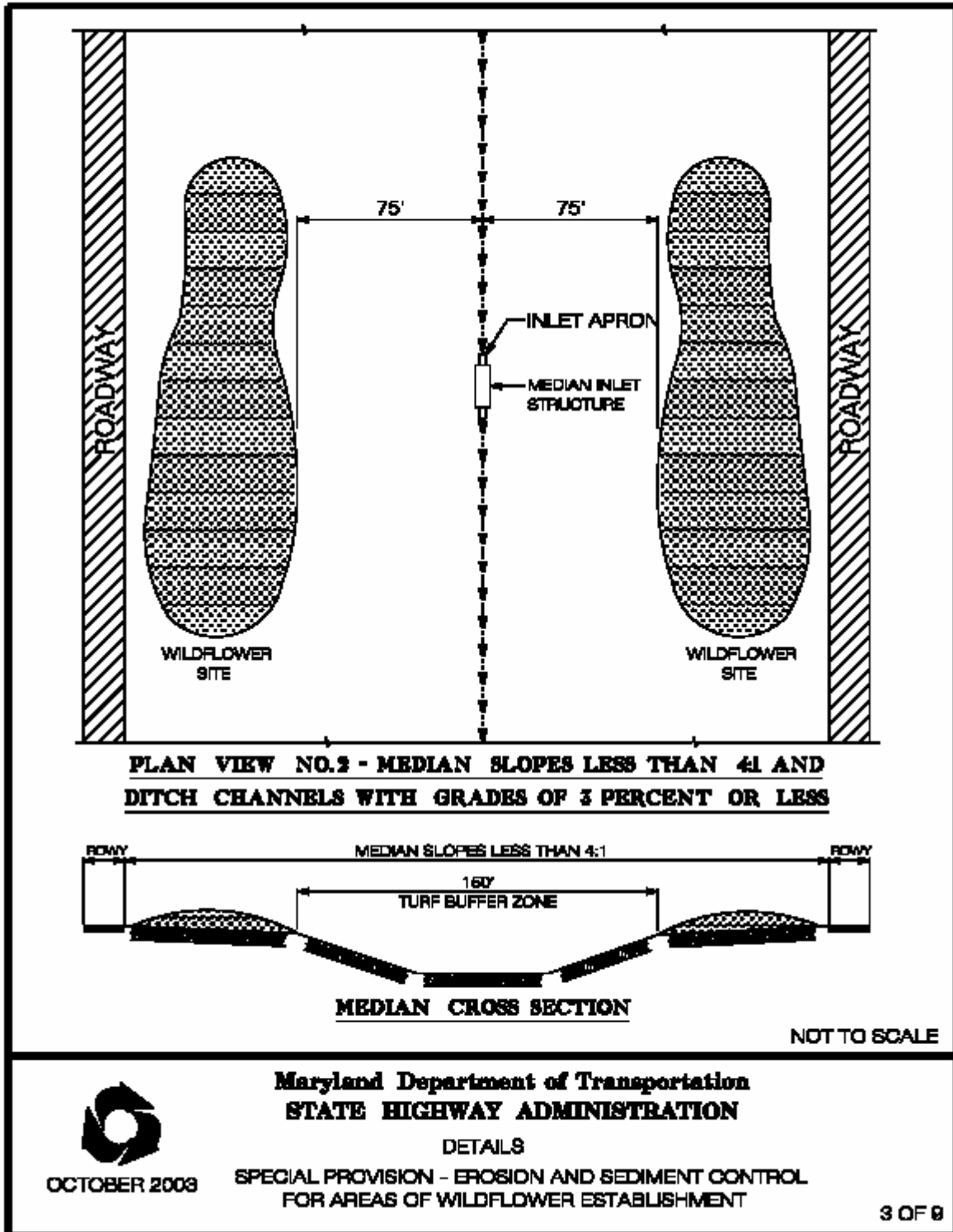

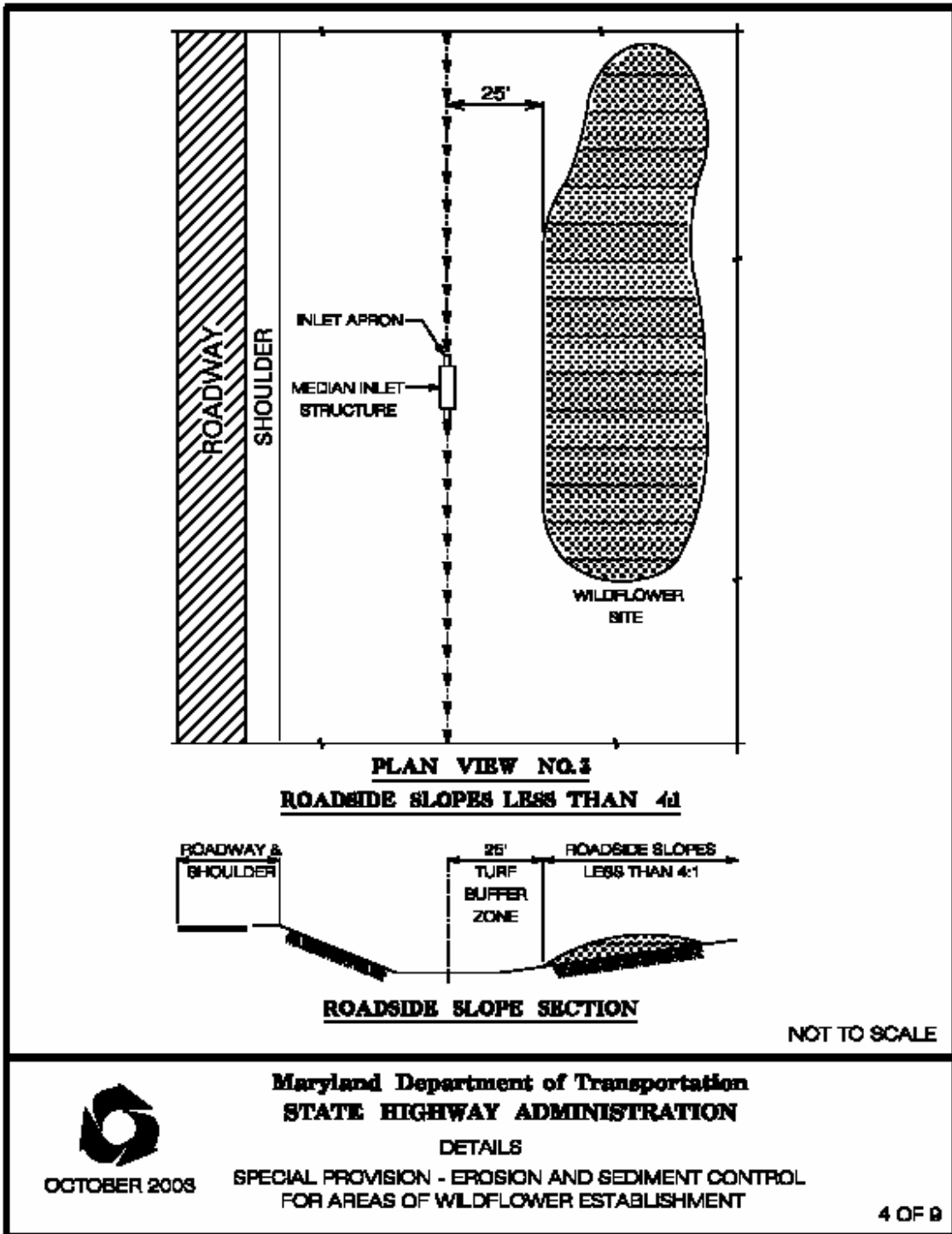

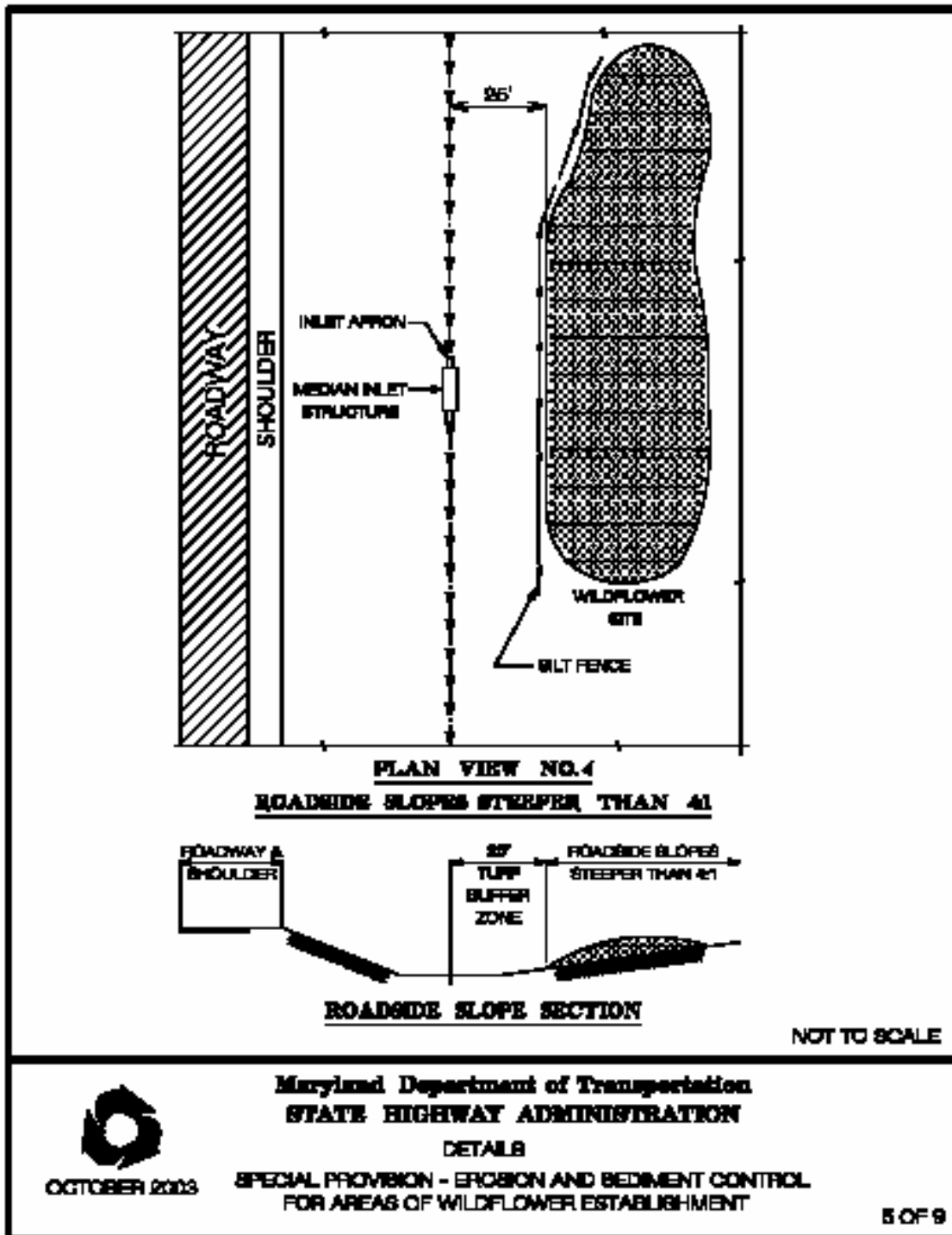

OCTOBER 2003

Maryland Department of Transportation
STATE HIGHWAY ADMINISTRATION

DETAILS

SPECIAL PROVISION - EROSION AND SEDIMENT CONTROL
FOR AREAS OF WILDFLOWER ESTABLISHMENT

5 OF 9

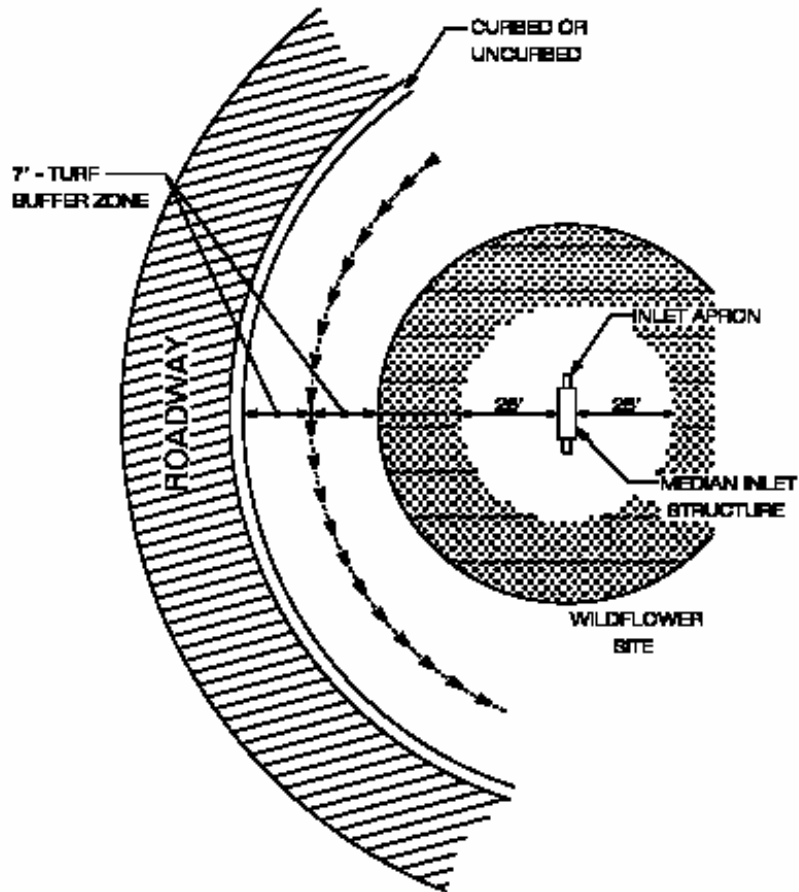

PLAN VIEW NO. 6
ROADSIDE RAMP - LESS THAN 4:1

NOT TO SCALE



OCTOBER 2003

Maryland Department of Transportation
STATE HIGHWAY ADMINISTRATION

DETAILS

SPECIAL PROVISION - EROSION AND SEDIMENT CONTROL
FOR AREAS OF WILDFLOWER ESTABLISHMENT

6 OF 9

8 OF 9

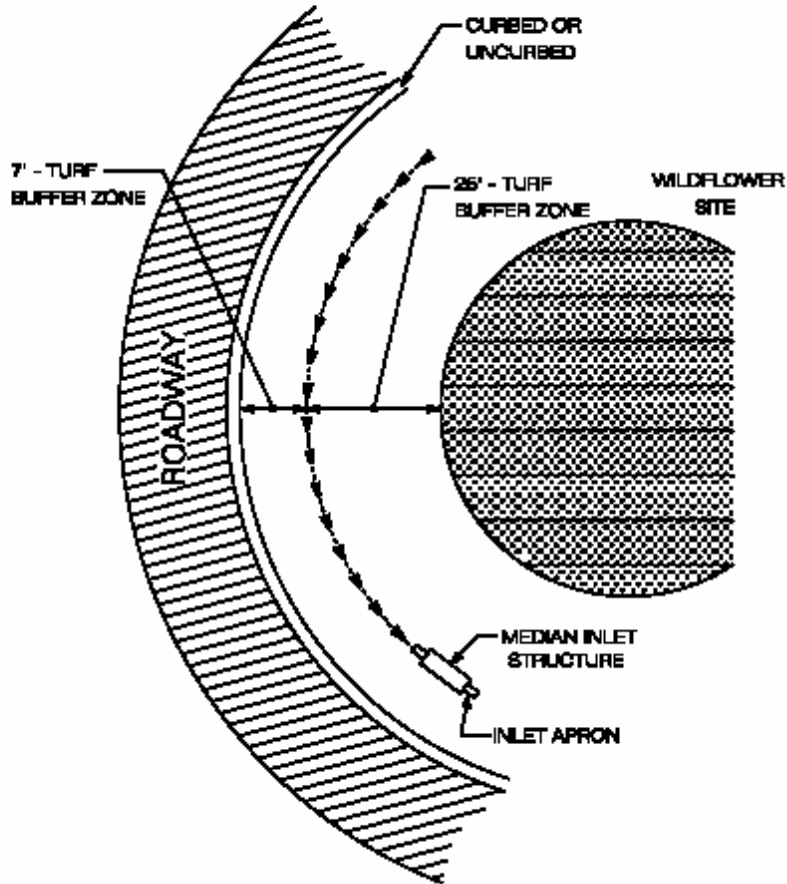

PLAN VIEW NO.6
ROADSIDE RAMP - STEEPER THAN 4:1

NOT TO SCALE



OCTOBER 2003

Maryland Department of Transportation
STATE HIGHWAY ADMINISTRATION

DETAILS

SPECIAL PROVISION - EROSION AND SEDIMENT CONTROL
FOR AREAS OF WILDFLOWER ESTABLISHMENT

7 OF 8

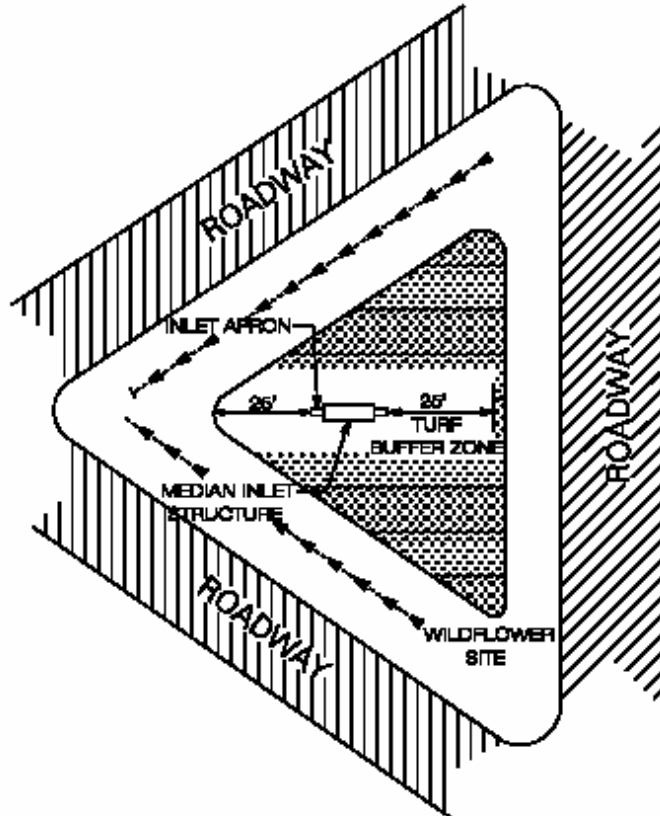

PLAN VIEW NO.7
TRIANGLE INTERSECTION - LESS THAN 41

NOT TO SCALE



Maryland Department of Transportation
STATE HIGHWAY ADMINISTRATION
DETAILS
SPECIAL PROVISION - EROSION AND SEDIMENT CONTROL
FOR AREAS OF WILDFLOWER ESTABLISHMENT

8 OF 9

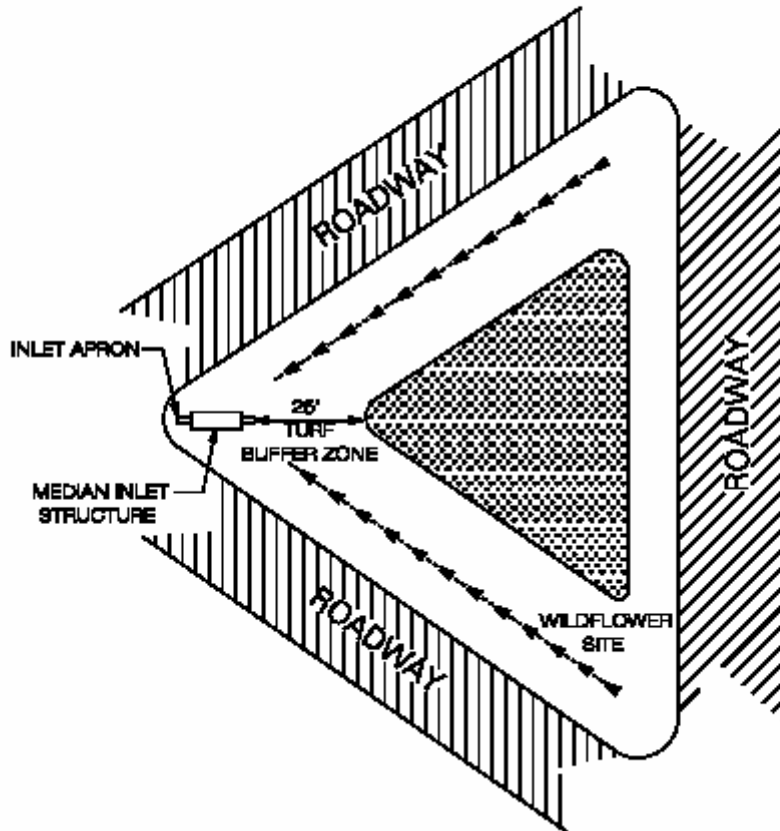

PLAN VIEW NO.8
TRIANGLE INTERSECTION - STEEPER THAN 4:1

NOT TO SCALE



OCTOBER 2003

Maryland Department of Transportation
STATE HIGHWAY ADMINISTRATION

DETAILS

SPECIAL PROVISION - EROSION AND SEDIMENT CONTROL
FOR AREAS OF WILDFLOWER ESTABLISHMENT

9 OF 9

Wildflower Identification Guide

Bachelor's Button (*Centaurea cyanus*): This annual, also known as corn flower, is a common wildflower along roadsides and fields. The original flower color is blue, but is now available in white, pink and red. It prefers full sun and can tolerate various soil types.



Black Eyed Susan (*Rudbeckia hirta*): A biennial that does well in most soils with full sun. Flowers have bright yellow ray florets with brown-black centers. It blooms generally late June through September. The Black Eyed Susan is Maryland's State flower.



Blanket Flower (*Gaillardia aristata*): This is the perennial cousin to *Gaillardia pulchella*, an annual. It prefers hot, dry sandy conditions. It is very drought tolerant. Flowers are a little larger than the annual, often up to 3 or 4 inches across. Blooms mid to late season, reaches 2 to 3 feet in height and likes full sun. It provides a real spectacle of color. It takes some time to develop, but when established, is a great addition to all meadows.



Calendula (*Calendula officinalis*): This easy to grow annual blooms early spring and late season growing 1 to 2 ft. in height and prefers full sun. Due to its short stature and late blooming, it shows best on the edge of a meadow. It is somewhat frost-tolerant. Calendula is one of the few wildflowers that appreciate a covering of soil for germination.



California Poppy (*Eschscholzia californica*): An annual that is upright, compact, and drought tolerant and ideal for dry environments. Brilliant orange, cup-shaped flowers are 2 to 4 inches in diameter, borne individually on long stalks. It prefers full sun and light to sandy soils. The blooms close each night at sunset or on gloomy days.



Corn Poppy (*Papaver rhoeas*): A hardy annual with large 3 to 4 inch blooms range in color from white and pink to red and are individually borne on erect hairy stems. It prefers well drained soil in full sun and performs best in early spring.



Cosmos (*Cosmos bipinnatus*): A quick blooming annual that creates brilliant colors of white, pink, lavender and crimson. Plants are not winter hardy and need replanting each spring to be successful.



Wildflower Identification Guide

Crimson Clover (*Trifolium incarnatum*): This is an annual clover that not to be confused with the tough perennial red clover used commonly in agriculture. Annual crimson clover has deep red blooms on a short attractive plant. It blooms from March to May, grows to a height of 15 inches and likes full sun. It is also used to reclaim eroded soil.



Dame's Rocket (*Hesperis matronalis*): This perennial blooms early in the season and reaches 2-3 feet. It can tolerate sun or part shade. It makes a great show, especially as a companion with Shasta Daisy. The flowers are purple-pink in clusters on tall stems with a clove-like scent. This wildflower likes moist conditions, but is quite adaptable.

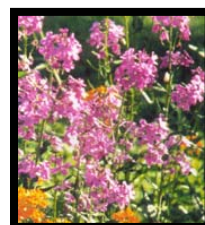

Indian Blanket (*Gaillardia pulchella*): This is the annual version of the familiar native "blanket flower". Gaillardias are natives of hot, dry, sandy plains. This species, like its perennial counterpart, can add brilliant color to any meadow. It blooms mid and late season and grows to 2 feet and needs full sun.



Lance- Leaved Coreopsis (*Coreopsis lanceolata*): A drought tolerant perennial that can also withstand long periods of moisture. Flowers are bright yellow on a single stem providing a very showy scene when massed. It does excellent in raised beds and blooms from May to October.



Lemon Mint (*Monarda citriodora*): A hardy annual or tender perennial depending on location. Deep purple to lavender flowers are arranged in whorls up a square stem. It blooms from May to September and attracts butterflies and hummingbirds. It can tolerate very dry conditions.



New England Aster (*Aster novae-angliae*): It is a perennial that blooms on stiff stems with glorious large purple flowers late in the season. It grows to a height of 3 to 4 feet and likes full sun. Likes soil that is not heavily acid, but it is a tough meadow plant and quite adaptable.



Wildflower Identification Guide

Plains Coreopsis (*Coreopsis tinctoria*): It is an annual with shiny green stems and ball-shaped brown buds. Blooms mid and late season, grows to 2 feet and has clusters of bi-color golden flowers with mahogany centers that literally light up a meadow. Enjoys rich soil, but is adaptable almost anywhere there is good, strong sun.



Purple Coneflower (*Echinacea purpurea*): A long lived perennial presenting a course-textured that has flowers supported by a sturdy 12 to 24 inch hairy, ridged stem. Flowers have drooping, lavender pedals 1 to 2 inches long that surround a purplish-brown, bristled center cone. It prefers well-drained, fertile conditions and soil pH of 6.0 to 7.0.



Rocket Larkspur (*Delphinium ajacis*): An annual that grows quickly, blooms heavily, and then dies with heat. The bloom comes mid spring to July and reaches 2 to 3 feet. It needs full sun and good drainage, but also a good amount of moisture to do well. Spikes of pink, deep blue or white flowers dry easily; they also add great color to meadows.



Scarlet Sage (*Salvia coccinea*): It is a hardy annual and a favorite for attracting hummingbirds. The fluorescent red tubular flowers are concentrated in whorls surrounding a square stem. It prefers sandy to gravelly soil in full sun to partial shade.



Shasta Daisy (*Chrysanthemum maximum*): A perennial that blooms a second season and successive seasons from expanding clumps early to mid season. It grows 2-3 feet in height and is somewhat larger and taller than our common wild Ox-Eye daisy.



Siberian Wallflower (*Cheiranthus allionii*): A biennial in cold climates or a perennial in warmer places. The bloom season is early and the growth height is about a foot. It has one of the most brilliant orange flowers of all. They like full sun or light shade and will grow in any soil, moist or dry.



Wildflower Identification Guide

Spurred Snapdragon (*Linaria maroccana*): A short annual also known as Toadflax. It blooms early spring to July with bright pink, red, yellow, and purple bi-colored blooms along upright stems. It grows quickly, blooms heavily, than dies with the heat of the summer. It re-grows prolifically if seed falls on bare ground. *Linaria* enjoys loose, sandy soil and prefers sun.



Sweet William (*Dianthus barbatus*): This annual blooms early to mid-season and is about 15 inches tall. It likes full sun or partial shade. Sweet William does not like heavily acid soils or summers that are extremely hot and it requires plenty of water. The wide range of colors and bi-color blooms, usually white and pink, make this a truly spectacular wildflower.



White Yarrow (*Achillea millefolium*): This perennial can thrive in moist or dry soil, and when established is very drought-tolerant. Blooms early through late season, reaches 1 to 2 feet and likes sun or shade. Yarrow can easily dominate and crowd out other wildflowers and should be used sparingly in wildflower mixes. Deep green ferny foliage appears and stays healthy all season. Dusty white flowers are lovely and frequent.



Yellow Cosmos (*Cosmos sulphureus*): This annual's bloom color varies from marigold/lemon yellow to bright orange and blooms mid-summer through frost. It is smaller-flowered and shorter than the *Cosmos bipinnatus* reaching heights of 3 feet. Sulphur cosmos is very adaptable and drought tolerant.



Seeding and Blooming Schedule

GENUS/SPECIES COMMON NAME	TYPE: Annual Biennial Perennial	PLANT BY: Broadcast Drill Plug Hydroseed	January	February	March	April	May	June	July	August	September	October	November	December
Achillea millefolium White Yarrow	P	B, D,												
Aster novi-angliae New England Aster	P	B, D,P												
Calendula officinalis Calendula	A	B, D												
Centauria cyanus Bachelor's Button	A	B, D,H												
Cheiranthus allionii Siberian Wallflower	P	B,D,H												
Chrysanthemum maximum Shasta Daisy	P	B,D,H												
Coreopsis lanceolata Lance-leaved Coreopsis	P	B,D,H												
Coreopsis tinctoria Plains Coreopsis	A	B, D,H												
Cosmos bipinnatus Cosmos Mixed Colors	A	B,D												
Cosmos sulphureus Sulphur Cosmos	A	B,D												
Delphinium ajacis Rocket Larkspur	A	B,D,H												
Echinacea purpurea Purple Coneflower	P	B,D,H,P,												
Eschscholzia californica California Poppy	A	B,D,H												
Gaillardia aristata Blanketflower	P	B,D,H,P,												
Gaillardia pulchella Firewheel	A	D,H,												
Hesperis matronalis Dames Rocket	P	B,D,H												
Linaria maroccana Spurred Snapdragon	A	D												
Monarda citriodora Lemon Mint	A	D												
Papaver rhoeas Corn Poppy Mixed	A	B, D,												
Papaver rhoeas red Red Corn Poppy	A	B, D,												
Rudbeckia hirta Black-Eyed Susan	A/B	B,D,H												
Salvia coccinea Scarlet Sage	A/P	B,D,												
		NOTES:												
		Indicates Planting Season.												
Colors		Indicate Bloom Season and Color Representation.												

ACTIVE INGREDIENT	The portion of the chemical formulation directly responsible for herbicidal effects.
ANNUAL	A plant that completes its life cycle in one year, i.e., germinates from seed, produces seed and dies in the same season. Examples: pigweed, ragweed, mustard, foxtail, and crabgrass.
ARBORIST	A person with technical knowledge of tree care practices gained through experience and training.
AVOIDUPOIS	Goods sold by weight.
BASAL TREATMENT	An application to the trunks of plants at and just above the ground line.
BIENNIAL	A plant that completes its life cycle in two years. The first year it produces leaves and stores food. The second year it blossoms and produces fruits and seeds. Examples: yellows rocket, wild carrot, common mullen, bull and musk thistle and burdock.
BRANCH	A stem arising from the trunk or another stem.
BRANCH BARK RIDGE	A raised area of bark tissue in the branch crotch, typically darker than surrounding bark.
BRANCH COLLAR	Overlapping trunk and branch tissue forming a swelling around the base of many branches.
BRANCH STUB	The part of the branch beyond the collar inadvertently left on the tree after a pruning.
BROADCAST APPLICATION	An application of spray over an entire area rather than only on individual plants.
BROADLEAFED PLANTS	In general, opposed to grass-like plants and conifers. Examples are ragweed, thistle and poison ivy.
BRUSH CONTROL	Control of woody plants.
CALLUS	Undifferentiated tissue formed by the cambium layer. See also <i>Cambium</i> .

CAMBIUM	The layer of dividing cells beneath the bark.
CANKER	A depression in the bark, usually caused by a fungus or bacterium.
CANOPY	See <i>Crown</i> .
CANOPY RESTORATION	The process of improving the structure of a tree that was previously topped, damaged, or over thinned.
CARRIER	The liquid or solid material added to a chemical or formulation to facilitate its preparation, storage, shipment or use in the field. (See also “diluent”).
CENTRAL LEADER	The dominant stem located more or less in the center of the crown.
CERTIFIED ARBORIST	An arborist who has passed an exam and receives, on a regular basis, continuing education administered by the International Society of Arboriculture.
CHEMICAL	See “Active Ingredient”.
CHLOROSIS	Loss of green color in foliage.
CLUSTERED BRANCHES	Branches that are closely spaced, originating from nearly the same place on the trunk.
COMPATIBLE	Two compounds or products are said to be compatible when they can be mixed without affecting each other’s performance.
CONDOMINANT STEM	A stem growing at about the same rate, and with nearly the same diameter, as another stem.
CONIFER	Cone bearing trees and shrubs that are usually evergreen.
CONTACT	One that kills primarily by contact with plant tissue rather than as a result of translocation. Only that portion of a plant contacted is directly affected. Young seedlings are killed but perennials may recover from the uninjured parts below ground.

COLLAR	See <i>Branch collar</i> .
CROTCH	The place where the trunk and a branch, or two branches, meet.
CROWN	The foliated portion of a tree, from the lowest branch to the treetop: synonymous with <i>canopy</i> .
CROWN CLEANING	The removal of dead, dying, broken, diseased, weak, and touching branches and sprouts.
CROWN REDUCTION	A reduction in the height or spread of the crown using drop crotch cuts.
CROWN THINNING	The removal of lateral branches, especially towards the ends of the major branches.
CULTURAL PROBLEMS	Too little or too much light, water, or fertilizer, or pest infestation resulting in poor growth.
DECAY	Degradation of tissue caused by biological organisms.
DECURRENT	Round-headed tree form; no leader to the top of the crown.
DECIDUOUS	Indicates plants which lose their leaves during the winter.
DILUENT	Any liquid or solid material serving to dilute or carry an active ingredient of formulation.
DOGLEG	Typically, an S-shaped bend in the tree trunk.
DOMINANT TRUNK	A stem with a diameter at least 1/3 bigger than other stems.
DORMANT SPRAY	Chemical applied in winter or very early spring. Example: winter basal treatment or brush or trees.
DOUBLE LEADER	Two co-dominant stems growing more or less in the center of the tree and jointly assuming the role as the leader.
DRY FLOWABLE	A granular that will form a suspension in water.

EFFICACY	The power to produce an effect.
EMERGENCE	The act of the germinating seedling breaking through the soil surface. This often is a preferred stage for selective herbicide application, with chemicals such as 2,4-D and Garlon.
EMULSION	A mixture in which one liquid is suspended in minute globules in another liquid. For example; milk or an oily preparation in water.
FLUSH CUT	An improper pruning cut made on the trunk side of the branch bark ridge or through the branch collar.
FROST CRACK	A split in the wood of a trunk or branch that extends out through the bark.
GERMINATION	Process of germinating or beginning of vegetative growth. Often refers to the beginning of growth from a seed.
HEADING	Pruning a shoot no older than two years back to bud; cutting an older stem back to a lateral branch less than 1/3 the diameter of the cut branch; cutting a stem indiscriminately.
HERBACEOUS	A plant that remains soft or succulent and does not develop woody tissue.
HERBICIDE	A phytotoxic chemical used for killing or inhibiting (stunting) the development or growth of plants.
HORMONE	A growth-regulating substance occurring naturally in plants or animals. It also refers to certain man made or synthetic chemicals with growth regulating activity. However, these are more correctly called synthetic growth regulators; they are not hormones.
INCLUDED BARK	Bark pinched between two stems preventing formation of a branch bark ridge.
LARGE-MATURING TREE	Trees that mature at a height greater than about 40 feet.

LATENT BUD	A suppressed bud, capable of forming a shoot, that grows enough to stay about even with the bark.
LATERAL	A stem or branch arising from a larger stem or branch.
LEACHING	Usually refers to downward and/or lateral movement of water through the soil, which may be soluble plant foods or other chemicals.
LEADER	The dominant stem usually develops into the main trunk.
LIMB	A large branch.
LION-TAILING	The improper practice of removing all secondary branches from main branches except those at the end.
LOPPER	A tool best suited for cutting branches once they have been removed from the tree.
MAJOR LIMBS	See <i>Scaffold branch (limb)</i> .
MATURE TREES	Trees that have reached at least 75 percent of their final height and spread.
NEGLECTED TREE	A poorly formed tree that has not been pruned for some time.
NODE	The point on the stem where the leaf and bud arise. Branches arise from nodes.
NON-SELECTIVE HERBICIDES	Chemicals or formulations which destroy or prevent plant life in general without regard to species.
NOXIOUS WEED	A weed arbitrarily defined by law as being especially undesirable, troublesome or difficult to control. Examples: Johnsongrass, Canada thistle and others.
OVERTHINNING	Removal of too much foliage, typically from the interior portion of the crown or lower portion of the limbs.

PARENT BRANCH	A main branch from which lateral branches arise.
PERENNIAL	A plant that continues to live from year to year. In many cases, in cold climates, the tops die down but the roots and rhizomes persist. Examples: field bindweed, Canada thistle, chicory, Johnsongrass, wild garlic, Bermudagrass, quack-grass, dandelion and goldenrod.
PERMANENT LIMB	A branch that remains on the tree for a long time, perhaps until maturity. See also <i>Scaffold branch (limb)</i> .
POST-EMERGENCE TREATMENT	Treatment made after plants emerge above the soil surface.
PREEMERGENCE TREATMENT	Treatment made before growth emerges.
REGULAR PRUNING	Pruning at a more or less set interval, such as yearly.
RESIDUAL	To have a continued killing effect over a period of time.
SCAFFOLD BRANCH (LIMB)	A branch that is among the largest on the tree.
SECONDARY BRANCH	See <i>Lateral</i> .
SENSITIVE	Not capable of withstanding effects. Example: many broadleaved plants are sensitive to 2,4-D; grasses are sensitive to glyphosate.
SMALL-MATURING TREE	A tree that reaches about 25 to 30 feet high at maturity.
SOIL RESIDUAL	In connection with herbicides, a material when present on or in soil, prevents the growth of plants. Residual herbicides may be temporary or relatively permanent depending on amount of material used.

SPRAY DRIFT	The movement of air-borne spray particles from the intended contact area to other areas.
STANDARD	A tree or large shrub trained into one short, straight trunk with a dense, round crown.
STEM	A woody structure bearing buds and foliage that can give rise to other stems and support leaves flowers and fruit.
STEM BARK RIDGE	Raised bark in the crotch between two more or less equally sized stems.
STRUCTURAL PRUNING	Pruning that influences the orientation, spacing, growth rate, strength of attachment, and ultimate size of the branches.
STRUCTURE	The spacing, orientation, and size of the branches relative to the trunk; the arrangement of the trunk and branches; the tree's architecture.
STUB	A piece of branch left beyond the collar after a pruning cut.
SUBORDINATION	Removing lateral branches or the terminal portion of the parent branch to slow growth rate of the parent branch.
SUNSCALD	A flattened, dried, or sunken area of the bark resulting from overexposure to the sun.
SURFACTANTS	Surface active agents, emulsifiers, detergents, spreaders, and dispersing agents capable of improving the effectiveness of the herbicide.
SUSPENSION	A liquid in which a liquid or fine solids are suspended or dispersed: when not agitated settle to the bottom.
SYSTEMIC	Herbicides that can be absorbed by either the roots or above ground parts and move, or are translocated through the plant system.
TAPER	The thickening of the stem or branch near its base.

THINNING	A type of pruning cut that removes a lateral branch back to the branch collar on the parent branch.
TOLERANT	Capable of withstanding effects. For example grass is tolerant to 2,4-D to the extent that this herbicide can be used selectively to control broadleaved weeds without killing the grass.
TOPPING (TOP)	An inappropriate technique that cuts through a stem at an indiscriminate location; a type of pruning cut that serves to initiate decay in the cut stems.
TOXIC	Poisonous; injurious to animals or plants through contact or systemic action.
TRANSLOCATION	Transfer of chemical or other materials from one part to another in plants.
TRIMMING	Clipping the ends of young branches using heading cuts.
UTILITY ARBORIST	An arborist with special training who prunes trees near wires and other utility equipment.
VAPOR DRIFT	The movement of vapors from the area of application to other areas.
VIGOROUS	Growing faster than others; aggressive.
VOLATILITY INJURY	Injury from the vapors of a herbicide.
VORTEX	A liquid with a whirling or circular motion that tends to form a vacuum. This allows air to replace liquid during the suction process at the tank outlet causing significant interruption of nozzle output.
WATER SPROUTS	Stems arising from the interior branches, often as a result of stimulation by over pruning or other stress on the tree.
WEAK CROTCH	A crotch with included bark.
WEED	A plant that grows where it is not wanted and does more harm than good.

WETTING AGENT	A surfactant used to increase the liquid's ability to moisten the leaf surface.
WIND THROW	When a tree falls over due to a strong wind.
WOODY PLANTS	Plants that develop woody tissue.
WOUND	An opening in the bark created by an injury or pruning.
WOUNDWOOD	Differentiated woody tissue forming around a wound, such as a pruning cut.